

Installation Instructions

Steel Gutter Mount VAN RACK Models 1502005/1502008

(2 bars Black & White)

Models 1502006/1502009

(Single Bar Black & White)

Bill of Materials

QTY.	DESCRIPTION
2	Upright Crossrail
2	Upright Insert
2	Cargo Positioners
4	Gutter Clamps
8	Carriage Bolt (3/8"-16 x 1")
2	5/8" Hex Head Set Bolt
8	Flat Washer
12	Lock Washer
12	Hex Head Nut

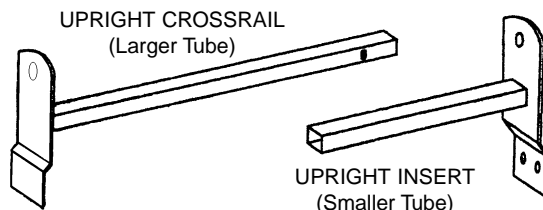
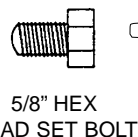
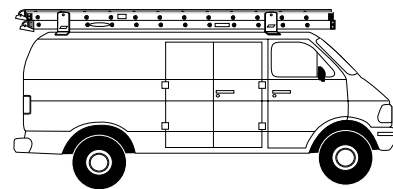

Tools Needed for Assembly

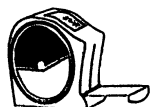

Assembly

1. Check your vehicle owner's manual for recommended roof load capacity and recommended rack placement. Roofs are generally strongest at the ends and at posts.
2. Install cargo positioners on the larger tube size (1³/₄" where they are most useful to you. Secure positioners with flat plate, 2 lock washers, and 2 nuts (2a).

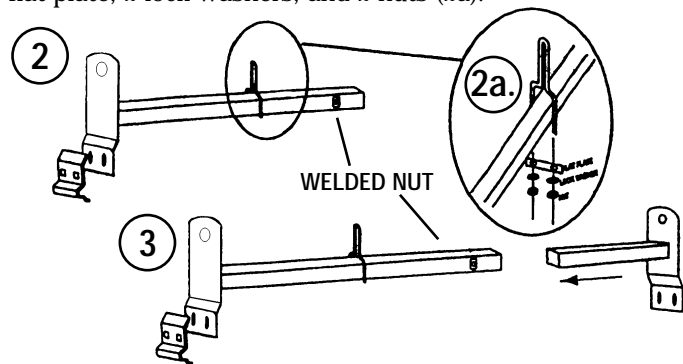

3. Slip the upright/insert into the crossrail and set the rack into the gutter. Make sure the insert lies flat in the gutter for secure fit. Be sure both upright inserts are on the same side of the van so all inserting goes the same way.

4. Hook the gutter clamps over the gutter and attach with 2 carriage bolts, flat washers, lock washers & nuts. On GMC/CHEVY 1997-2000 Vans you might need to start with tightening just a bolt and nut, at which point the clamp will adjust to the caulk and allow room on the bolt for the washers.

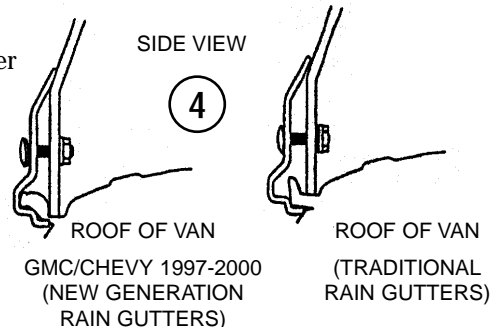

5. Repeat step 4 on three remaining assemblies.
6. After securing the rack to the gutters, screw the 5/8" set bolt into the welded nut.
7. Periodically check mounting hardware for tightness.
8. To prolong the life of your new van racks, we recommend caulking the area where tubes telescope and all weld nuts with a clear silicone sealant.

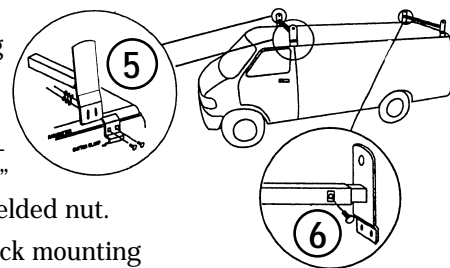

Warranty Information

Buyers Products warrants all truck/trailer hardware manufactured or distributed by it, to be free from defects in material and workmanship for a period of one year from date of shipment. Parts must be properly installed and used under normal conditions. Any product which has been altered, including modification, misuse, accident or lack of maintenance will not be considered under warranty. Normal wear is excluded. The sole responsibility of Buyers products under this warranty is limited to repairing or replacing any part or parts which are returned, prepaid, and are found to be defective by Buyers Products. Authorization from Buyers Products must be obtained before returning any part. No charges for transportation or labor performed on Buyers' products will be allowed under this warranty.