



SNOWDOGG® SNOW PLOWS

FEATURING NEW

**MXII Series
1/2 Ton Truck Plow**

See pg. 14 - 15



**ScoopDogg Pushers
by Buyers** *See pg. 6 - 7*

NOTHING WORKS LIKE A DOGG™

Snow Plow Specifications

MX

Full Size Plow Features for Lighter Trucks

1/2 Ton Trucks, Jeeps, and SUVs



Medium Duty Plows (pg. 14-15)

Specifications	MX68II*	MX75II*	MX80II*
Width	80"	90"	96"
Blade Height	24"	24"	24"
Material	SS	SS	SS
Thickness	.075"	.075"	.075"
Angle Cylinders	1½" x 10"	1½" x 10"	1½" x 10"
Lift Cylinder	1½" x 6"	1½" x 6"	1½" x 6"
Kingpin Size	1"	1"	1"
Width at Angle	69.2"	78"	83"
Ribs	6	8	10
Springs	2	2	2
Trip Style	Full	Full	Full
Cutting Edge	3/8" x 6"	3/8" x 6"	1/2" x 6"
Weight ¹	452 lb	482 lb	525 lb
Deflector	Std.	Std.	Std.
Shoes	Cast	Cast	Cast

¹ Weight Not Including Truck Mount, 40-80lbs. Typical Weight

HD

Heavy Duty Full Trip Plow, Weight Optimized for Lighter Trucks

1/2 Ton Trucks with Plow Prep, 3/4 Ton and Heavier Trucks



Heavy Duty Plows (pg. 18-19)

Specifications	HD75II	HD80II
Width	90"	96"
Blade Height	29"	29"
Material	SS	SS
Thickness	.105"	.105"
Angle Cylinders	1½" x 12"	1½" x 12"
Lift Cylinder	2" x 6"	2" x 6"
Kingpin Size	1-1/8"	1-1/8"
Width at Angle	78"	83"
Ribs	9	9
Springs	4	4
Trip Style	Full	Full
Cutting Edge	3/8" x 6"	3/8" x 6"
Weight ¹	680 lb	700 lb
Deflector	Std.	Std.
Shoes	Cast	Cast

¹ Weight Not Including Truck Mount, 40-80lbs. Typical Weight

EX

Commercial Duty Full Trip Plow

3/4 Ton Trucks with Plow Prep, 1 Ton and Heavier Trucks



Commercial Duty Plows (pg. 20-21)

Specifications	EX80II	EX85II	EX90II
Width	96"	102"	108"
Blade Height	31"	31"	31"
Material	SS	SS	SS
Thickness	.105"	.105"	.105"
Angle Cylinders	1½" x 12"	1½" x 12"	1½" x 12"
Lift Cylinder	2" x 6"	2" x 6"	2" x 6"
Kingpin Size	1⅛"	1⅛"	1⅛"
Width at Angle	83"	88.3"	93.5"
Ribs	9	9	9
Springs	4	4	4
Trip Style	Full	Full	Full
Cutting Edge	1/2" x 6"	1/2" x 6"	1/2" x 6"
Weight ¹	765 lb	785 lb	805 lb
Deflector	Std.	Std.	Std.
Shoes	Cast	Cast	Cast

¹ Weight Not Including Truck Mount, 40-80lbs. Typical Weight

TE

Commercial Duty Trip Edge Plow

3/4 Ton Trucks with Plow Prep, 1 Ton and Heavier Trucks



XP

Hydraulic Wings Expand from 8' - 10'

3/4 Ton Trucks with Plow Prep, 1 Ton Trucks and Up



Commercial Duty Trip Edge Plows (pg. 22-23)

Specifications	TE75II	TE80II	TE90II
Width	90"	96"	108"
Blade Height	31"	31"	31"
Material	SS	SS	SS
Thickness	.105"	.105"	.105"
Angle Cylinders	1½" x 12"	1½" x 12"	1½" x 12"
Lift Cylinder	2" x 6"	2" x 6"	2" x 6"
Kingpin Size	1⅛"	1⅛"	1⅛"
Width at Angle	78"	83"	94"
Ribs	8	8	8
Springs	4	4	4
Trip Style	Edge	Edge	Edge
Cutting Edge	3/8" x 6"	1/2" x 6"	1/2" x 6"
Weight ¹	705 lb	772 lb	812 lb
Deflector	Std.	Std.	Std.
Shoes	Cast	Cast	Cast

¹ Weight Not Including Truck Mount, 40-80lbs. Typical Weight;

Expandable Wing Plow (pg. 28-29)

Specifications	XP810II
Width	96"-120"
Blade Height	29"
Material	SS
Thickness	.105"
Angle Cylinders	1½" x 12"
Lift Cylinder	2" x 6"
Kingpin Size	1⅛"
Width at Angle	104"
Ribs	9
Springs	6
Trip Style	Full
Cutting Edge	1/2" x 6"
Weight ¹	1,150 lb
Deflector	Std.
Shoes	Cast

¹ Weight Not Including Truck Mount, 40-80lbs. Typical Weight;

Snow Plow Specifications

VMX

V Plow Versatility for Lighter Trucks

1/2 Ton Trucks



Medium Duty V Plow (pg. 16-17)

Specifications	VMX75II
Width	90"
Blade Height	27"/33"
Material	SS
Thickness	.075"
Angle Cylinders	1½" x 1¾" x 12"
Lift Cylinder	1½" x 6"
Kingpin Size	1"
Width at Angle	78"
Ribs	6
Springs	2
Trip Style	Edge
Cutting Edge	3/8" x 6"
Weight ¹	549 lb
Deflector	Std.
Shoes	Opt.

¹ Weight Not Including Truck Mount, 40-80lbs. Typical Weight

VXF



Commercial Duty V Plow

3/4 Ton Trucks with Plow Prep, 1 Ton Trucks and Up

VXX



Commercial / Municipal Duty V Plow

Class 4, 5, and 6 Trucks

Commercial Duty V Plows (pg. 24-25)

Specifications	VXF85II	VXF95II
Width	102"	114"
Blade Height	29"/37"	29"/38"
Material	SS	SS
Thickness	.105"	.105"
Angle Cylinders	1½" x 1¾" x 12"	1½" x 1¾" x 12"
Lift Cylinder	2" x 6"	2" x 6"
Kingpin Size	1"	1"
Width at Angle	88"	99"
Ribs	8	8
Springs	4	4
Trip Style	Edge	Edge
Cutting Edge	1/2" x 6"	1/2" x 6"
Weight ¹	978 lb	998 lb
Deflector	Std.	Std.
Shoes	Opt.	Opt.

¹ Weight Not Including Truck Mount, 40-80lbs. Typical Weight;

Commercial / Municipal Duty V Plow (pg. 26-27)

Specifications	VXX105II
Width	126"
Blade Height	35"/45"
Material	SS
Thickness	.105"
Angle Cylinders	1½" x 1¾" x 12"
Lift Cylinder	2" x 6"
Kingpin Size	1-1/4"
Width at Angle	109"
Ribs	8
Springs	4
Trip Style	Edge
Cutting Edge	5/8" x 6"
Weight ¹	1,038 lb
Deflector	Std.
Shoes	Opt.

¹ Weight Not Including Truck Mount, 40-80lbs. Typical Weight;

CM

Commercial / Municipal Plow

For Vehicles with 10,000 - 29,000 GVWR



Commercial / Municipal Plow (pg. 30-31)			
Specifications	CM90II	CM100II	CM110II
Width	108"	120"	132"
Blade Height	31"	31"	31"
Material	SS	SS	SS
Thickness	.105"	.105"	.105"
Angle Cylinders	2" x 12"	2" x 12"	2" x 12"
Lift Cylinder	2" x 6"	2" x 6"	2" x 6"
Kingpin Size	1 1/8"	1 1/8"	1 1/8"
Width at Angle	92"	104"	116"
Ribs	10 ²	10 ²	10 ²
Springs	6	6	6
Trip Style	Full	Full	Full
Cutting Edge	5/8" x 6"	5/8" x 6"	5/8" x 6"
Weight ¹	1,044 lb	1,084 lb	1,124 lb
Deflector	Std.	Std.	Std.
Shoes	Cast	Cast	Cast

¹ Weight Not Including Truck Mount, 40-80lbs. Typical Weight; ² Are Diagonal

SKTE

Skid Steer Plows with Hydraulic Angling and Trip Edges

Universal Skid Steer Mount



Skid Steer Plows (pg. 34-35)			
Specifications	SKTE75	SKTE80	SKTE90
Width	90"	96"	108"
Blade Height	31"	31"	31"
Material	SS	SS	SS
Thickness	.105"	.105"	.105"
Angle Cylinders	1 1/2" x 12"	1 1/2" x 12"	1 1/2" x 12"
Lift Cylinder	N/A	N/A	N/A
Kingpin Size	1 1/16"	1 1/16"	1 1/16"
Width at Angle	78"	83"	94"
Ribs	8	8	8
Springs	4	4	4
Trip Style	Edge	Edge	Edge
Cutting Edge	1/2" x 6"	1/2" x 6"	1/2" x 6"
Weight ¹	781 lb	848 lb	888 lb
Deflector	Std.	Std.	Std.
Shoes	Cast	Cast	Cast

¹ Weight Not Including Truck Mount, 40-80lbs. Typical Weight;

VUT / MUT

Hydraulically-Controlled Plows Specifically Designed for UTV Applications

Ideal for Sidewalks, Parks, and Campuses



UTV Plows (pg. 32-33)			
Specifications	VUT65	MUT60	MUT68
Width	72"	72"	80"
Blade Height	25" / 31"	24"	24"
Material	SS	SS	SS
Thickness	.075"	.075"	.075"
Angle Cylinders	1 1/2" x 1 3/4" x 8"	1 1/2" x 6"	1 1/2" x 6"
Lift Cylinder	1 1/2" x 6"	1 1/2" x 6"	1 1/2" x 6"
Kingpin Size	1 1/8"	1"	1"
Width at Angle	60"	63"	69"
Ribs	6	6	6
Springs	2	2	2
Trip Style	Edge	Full	Full
Cutting Edge	1/4" x 5"	1/4" x 5"	3/8" x 6"
Weight ¹	400 lb	310 lb	360 lb
Deflector	N/A	N/A	Included
Shoes	Opt.	Cast	Cast

¹ Weight Not Including Truck Mount, 40-80lbs. Typical Weight;

Snow Pusher Specifications

SKID-STEER SERIES PUSHERS



Skid-Steer (pg. 36-37)

Specifications	2603108	2603110	2603112
Width	8'	10'	12'
Blade Height	39"	39"	39"
Depth	37"	37"	37"
Moldboard Gauge	7 Ga	7 Ga	7 Ga
Moldboard Material	Carbon Steel	Carbon Steel	Carbon Steel
Wear Surface Material	AR400 Steel	AR400 Steel	AR400 Steel
Side Plate Thickness	5/16"	5/16"	5/16"
Side Plate Support	3" x 3" x 1/4"	3" x 3" x 1/4"	3" x 3" x 1/4"
Cutting Edge	1" x 8"	1" x 8"	1" x 8"
Wear Surface Thickness	3/4"	3/4"	3/4"
Minimum Horsepower	46	70	85
Minimum Machine Weight	5,500 lb	7,000 lb	10,000 lb
Weight	950 lb	1,125 lb	1,250 lb

Back Drag Kits

Specifications	9153008	9153010
Width	8' (For use with 2603108)	10' (For use with 2603110)
Weight	313 lb	366 lb

COMPACT SERIES PUSHERS



Compact Tractor (pg. 36-37)

Specifications	2604106	2604108	2604110
Width	6'	8'	10'
Blade Height	28"	28"	28"
Depth	31"	31"	31"
Moldboard Gauge	10 Ga	10 Ga	10 Ga
Moldboard Material	Carbon Steel	Carbon Steel	Carbon Steel
Wear Surface Material	AR400 Steel	AR400 Steel	AR400 Steel
Side Plate Thickness	1/4"	1/4"	1/4"
Side Plate Support	2" x 2" x 1/4"	2" x 2" x 1/4"	2" x 2" x 1/4"
Cutting Edge	1" x 6"	1" x 6"	1" x 6"
Wear Surface Thickness	3/4"	3/4"	3/4"
Minimum Horsepower	30	40	50
Minimum Machine Weight	2,500 lb	3,500 lb	4,500 lb
Weight	400 lb	500 lb	600 lb

LOADER SERIES PUSHERS



Loader (pg. 38-39)					
Specifications	2601112	2601114	2601116	2601118	2601120
Width	12'	14'	16'	18'	20'
Blade Height	47"	47"	47"	47"	47"
Depth	63"	63"	63"	63"	63"
Moldboard Gauge	7 Ga	7 Ga	7 Ga	7 Ga	7 Ga
Moldboard Material	Carbon Steel	Carbon Steel	Carbon Steel	Carbon Steel	Carbon Steel
Wear Surface Material	AR400 Steel	AR400 Steel	AR400 Steel	AR400 Steel	AR400 Steel
Side Plate Thickness	3/8"	3/8"	3/8"	3/8"	3/8"
Side Plate Support	4" x 4" x 3/8"	4" x 4" x 3/8"	4" x 4" x 3/8"	4" x 4" x 3/8"	4" x 4" x 3/8"
Cutting Edge	1-1/2" 10"	1-1/2" 10"	1-1/2" 10"	1-1/2" 10"	1-1/2" 10"
Wear Surface Thickness	1"	1"	1"	1"	1"
Minimum Horsepower	100	120	125	140	170
Minimum Machine Weight	13,000 lb	16,000 lb	25,000 lb	30,000 lb	40,000 lb
Weight	2,200 lb	2,400 lb	2,600 lb	3,000 lb	3,600 lb

BACKHOE SERIES PUSHERS



Backhoe (pg. 40-41)			
Specifications	2602110	2602112	2602114
Width	10'	12'	14'
Blade Height	39"	39"	39"
Depth	51"	51"	51"
Moldboard Gauge	7 Ga	7 Ga	7 Ga
Moldboard Material	Carbon Steel	Carbon Steel	Carbon Steel
Wear Surface Material	AR400 Steel	AR400 Steel	AR400 Steel
Side Plate Thickness	3/8"	3/8"	3/8"
Side Plate Support	4" x 4" x 3/8"	4" x 4" x 3/8"	4" x 4" x 3/8"
Cutting Edge	1-1/2" 10"	1-1/2" 10"	1-1/2" 10"
Wear Surface Thickness	3/4"	3/4"	3/4"
Minimum Horsepower	50	70	85
Minimum Machine Weight	12,000 lb	15,000 lb	16,000 lb
Weight	1,125 lb	1,450 lb	1,600 lb

Backhoe Accessories	
Part No.	Description
9151008*	8' Chain/Binder Kit
9151010*	10' Chain/Binder Kit

TUFF-KOTE™

MORE THAN DOUBLE THE LIFE OF YOUR PLOW

- SANDBLAST**
Remove all impurities and contaminants
- PRIME**
Seal and fill any inconsistencies in the material
- TOP COAT**
Acts as an additional primer and prepares the surface for the final treatment
- SUPER DURABLE POLYESTER POWDERCOAT**
Protects your plow from the elements for years to come



WINTER DOESN'T KEEP

THREE WAYS TO LIGHT UP THE NIGHT:



ILLUMINATOR™

HEATED LOW PROFILE LED LIGHTS *Patent Pending*



Part No. 16160900

Two Lights in One

Integrated 5 pattern strobes powered by 4 ultrabright Amber LEDs on each light.

Sleek Edgeless Low Profile Design

Aluminum die cast construction with heated, tempered glass lens to prevent ice build-up.

DOT Compliant LED Headlights

Twice as bright as standard halogen lights at half the power consumption.

Perfect SnowDogg Compatibility

Plug and Play compatibility with all current and past SnowDogg plows. Uses existing auxiliary wires in the lighting harnesses. No new connections when mounting the plow.



Included Controls & Hardware

Illuminator LP lights with adjustable bracket for easy aiming. Wire in-cab switch for strobes with "on/off" and flash pattern selector (with 15' of wire). Stainless Steel mounting hardware.



BANKER'S HOURS.

ILLUMINATOR™ HEATED LED LIGHTS



Part No. 16160800

Active Defrosting Technology™

Prevents streaky defrosting so 100% of the light shines through.

Brilliant Wide-Angle LEDs

Twice as bright as standard halogens at half the power consumption.

Long Lasting Power

Go years without changing a bulb.

HALOGENS HX HIGH INTENSITY



Part No. 16160700A

Powerful Halogens

Won't ice up in frigid conditions.

High Intensity Bulbs

Our brightest halogen bulbs ever.

Optimized Internal Reflectors

For focused high and low beams.

Dual-Post Captive Bolt Design

Vibration resistant for years of use.

Need More Light?

Check Page 42 for the **Illuminated LED Guides**

INSIST ON A PRODUCT



PRECISION WELDING

State-of-the-art robotic welding produces consistent, high quality welds for strong and durable joints.



METICULOUS QUALITY CONTROL

Each plow is inspected and tested at multiple points in its design and production cycle. Field and lab testing make sure plows are ready for the rigors of winter.



RAPID AVAILABILITY

When it comes to snow equipment, we realize no one has time to wait. That's why we stock a deep inventory of plows, electrical connectors, and mounts. Need an unusual mount? Give us a shout—we'll get it to you fast!

STATE-OF-THE-ART MANUFACTURING

FROM A COMPANY YOU CAN TRUST



FLOATING A-FRAME™

Our patented Floating A-Frame's sliding pin design lets SnowDogs bite the ground for a clean, even scrape. As a bonus, the design also promotes even cutting-edge wear.



UNSTOPPABLE HYDRAULICS

A fully-enclosed 2 HP hydraulic power unit combined with hefty 3/8" hoses and SAE standard cartridge valves give SnowDogs more responsive angling, stacking, and snow-throwing power.



EASY-TO-USE CONTROLS

The backlit one-handed controller puts all plow functions in the palm of your hand. It's simple to use, even with gloves on.

INNOVATIVE PRODUCT DESIGN

MOUNT AND DISMOUNT IN RECORD TIME WITH THE

RapidLink™ Attachment System

1. Enter Mount Mode

Hold the Down Button for one second to activate float mode (blue light).
Hold the Down Button again for one second to activate Mount Mode (red flashing light).



2. Drive Into the Plow and check for Alignment

IF

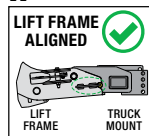

proceed to Step 4

IF

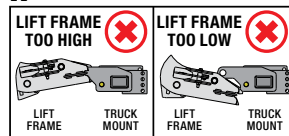

proceed to Step 3

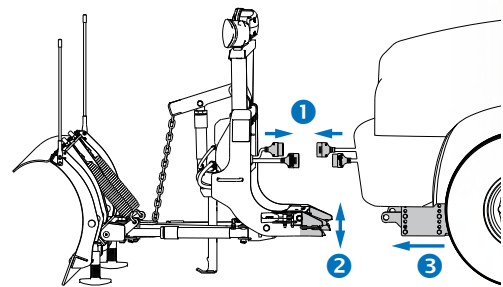

3. Lift Frame too High?

Push the JACK SWITCH into MOUNT (down) position to lower the rear of the lift frame.

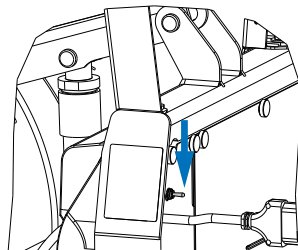

Lift Frame too Low?

Back up the truck 6"-12" to allow room to raise the plow receiver. Push the JACK SWITCH into DISMOUNT (up) position to raise the rear of the lift frame.

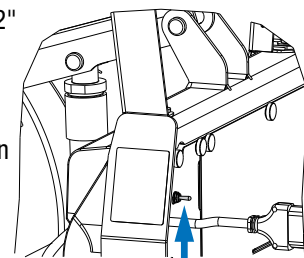

4. Push Switch Down then Push Chain Lift Down

Make sure there is slack in the chain

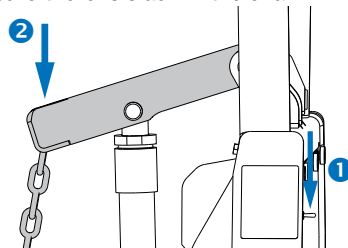

5. Pull Foot Pedal then Push on Light Tower

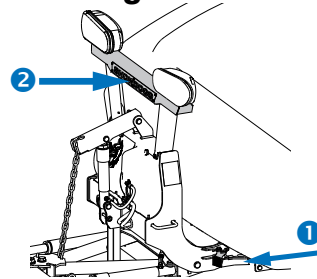

6. Insert Snapper Pin then Raise Drop Foot

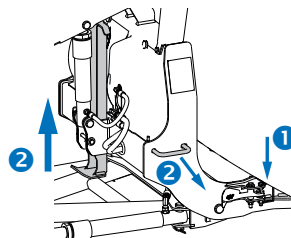

See mount/dismount instructions located on the moldboard for more information. Be sure to register your plow at www.BuyersProducts.com where you can also find installation instructions, technical specs and full parts diagrams.

Our simple and reliable RapidLink™ and Jack Switch allow you to adjust the plow's mounting height to different trucks or mounting conditions.



RapidLink is patent pending.

ALL NEW

MXIII

Full Plow Features for Lighter Trucks

1/2 Ton Trucks, Jeeps, and SUVs

STANDARD FEATURES

Full Size Features with Half the Weight

Weight optimized for 1/2 ton trucks or SUVs (even with no plow prep).

Floating A-Frame™

Contour the road for clean scraping and even cutting edge wear.

304 Stainless Steel Moldboard & 3/8" Steel Cutting Edge*

An investment that will last.

Six 1/4" Laser-Cut Steel Ribs and a Full-Length Cross Tube

Provides maximum strength and stability across the length of the plow.

Full Trip Action

Two stress-optimized trip springs protect from hidden curbs and obstacles.

**1/2" Steel Cutting Edge on MX80*

INCLUDED ACCESSORIES

Contoured Poly Snow Deflector

Cast Plow Shoes

Wire Reinforced Blade Guides

In-Cab Controller

Single hand operation.



Available Sizes
6'8", 7'6", 8'



Shown with Illuminator™ Low Profile
LED Plow Lights (16160900)

RapidLink™ Attachment System

Mount and dismount the plow in a
minute or less. See page 12 for details.



Optional Wings - Part No. | 16021410

Add 7-1/2" of scraping width to your plow with the MX Plow Wing Kit. Contain
snow trails with a 20 degree forward scoop. The cutting edge and curb guards
trip with your plow for a clean scrape.



VMX III

V Plow Versatility for Light Duty Trucks

1/2 Ton Trucks

STANDARD FEATURES

Full Size Features with Half the Weight
Weight optimized for lighter trucks.

Floating A-Frame™
Contour the road for clean scraping and even cutting edge wear.

304 Stainless Steel Moldboard & 3/8" Steel Cutting Edge
An investment that will last.

Six Laser-Cut Steel Ribs and Two Full-Length Cross Tubes
Provides maximum strength and stability across the length of the plow.

Double Acting Angle Cylinders
Back drag with confidence, even in tight spaces.

Trip Edge Design
Each wing has a 6" trip edge that protects from hidden curbs and obstacles.

INCLUDED ACCESSORIES

Contoured Poly Snow Deflector
Wire Reinforced Blade Guides
In-Cab Controller
Single hand operation.



Available Size
7'6"



Shown with Illuminator™
Heated LED Plow Lights

RapidLink™ Attachment System

Mount and dismount the plow in a minute or less. See page 12 for details.

Optional Wings - Part No. I 16021720

Add 7-1/2" of scraping width to your plow with the VMX Plow Wing Kit. Contain snow trails with a 20 degree forward scoop. The cutting edge and curb guards attach to your trip edge for a clean scrape.

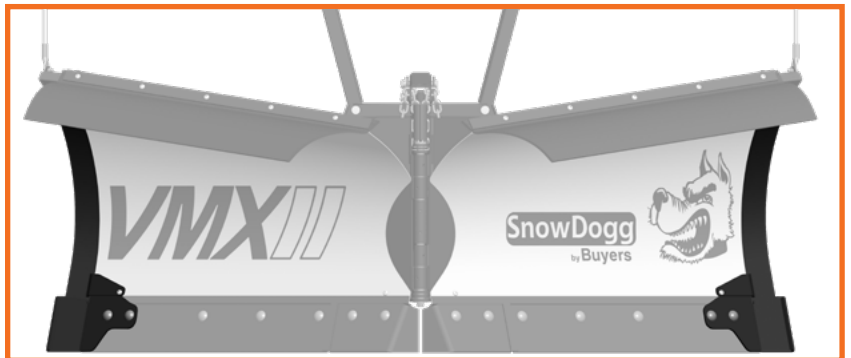

HD III

Heavy Duty Full Trip Plow, Weight Optimized for Lighter Trucks

1/2 Ton Trucks with Plow Prep, 3/4 Ton and Heavier Trucks

STANDARD FEATURES

Four Stress-Optimized Trip Springs

Protect your equipment from hidden curbs and obstacles.

Floating A-Frame™

Contour the road for clean scraping and even cutting edge wear.

Municipal Style Chain Lift

Stack high and adjust easily.

Fully Enclosed Hydraulic Power Unit

Gain easy access via large maintenance panel.

304 Stainless Steel Moldboard & 3/8" Steel Cutting Edge

An investment that will last.

Central Hydraulic-Operated Lift Frame Available

INCLUDED ACCESSORIES

Heavy Duty Shock Kit

Contoured Poly Snow Deflector

Cast Shoes

Wire Reinforced Blade Guides

Backlit Controller

Single hand operation.



Available Sizes
7'6", 8'



Shown with HX High Intensity Halogens
Also available with Illuminator™ Heated LED Plow Lights

RapidLink™ Attachment System

Mount and dismount the plow in a minute or less. See page 12 for details.

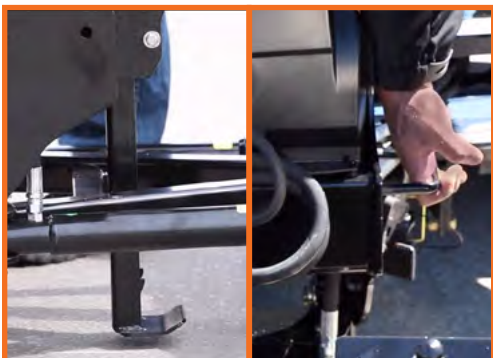

Optional Wings - Part No. I 16021510

Add a full 2' of width to your plow with the HD Series Plow Wing Kit. Wings rotate behind plow for easy stowage, no lifting required. Pin shears upon impact to protect from damage.



EXIII

Commercial Duty Full Trip Plow

3/4 Ton Trucks with Plow Prep, 1 Ton and Heavier Trucks

STANDARD FEATURES

Four Stress-Optimized Trip Springs

Protect your equipment from hidden curbs and obstacles.

Floating A-Frame™

Contour the road for clean scraping and even cutting edge wear.

Municipal Style Chain Lift

Stack high and adjust easily.

Fully Enclosed Hydraulic Power Unit

Gain easy access via large maintenance panel.

304 Stainless Steel Moldboard & 1/2" Steel Cutting Edge

An investment that will last.

Central Hydraulic-Operated Lift Frame Available

INCLUDED ACCESSORIES

Heavy Duty Shock Kit

Contoured Poly Snow Deflector

Cast Shoes

Wire Reinforced Blade Guides

Backlit Controller

Single hand operation.



Available Sizes
8', 8'6", 9'



Shown with Illuminator™
Heated LED Plow Lights

RapidLink™ Attachment System

Mount and dismount the plow in a minute or less. See page 12 for details.

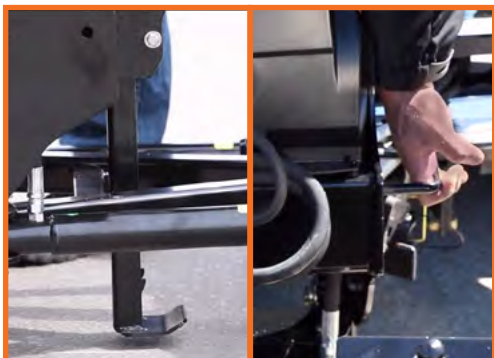

Optional Wings - Part No. I 16021610

Add a full 2' of width to your plow with the EX Series Plow Wing Kit. Wings rotate behind plow for easy stowage, no lifting required. Pin shears upon impact to protect from damage.



TE75II

Commercial Duty Trip Edge Plow

3/4 Ton Trucks with Plow Prep, 1 Ton and Heavier Trucks

STANDARD FEATURES

Trip Edge Design

Allows for plowing over obstacles. Great for gravel, dirt, or uneven roads.

Floating A-Frame™

Contour the road for clean scraping and even cutting edge wear.

Municipal Style Chain Lift

Stack high and adjust easily.

Fully Enclosed Hydraulic Power Unit

Gain easy access via large maintenance panel.

304 Stainless Steel Moldboard & 1/2" Steel Cutting Edge*

An investment that will last.

Central Hydraulic-Operated Lift Frame Available

**3/8" Steel Cutting Edge on TE75II*

INCLUDED ACCESSORIES

Contoured Poly Snow Deflector

Cast Shoes

Wire Reinforced Blade Guides

Backlit Controller

Single hand operation.



Available Sizes
7'6", 8', 9'

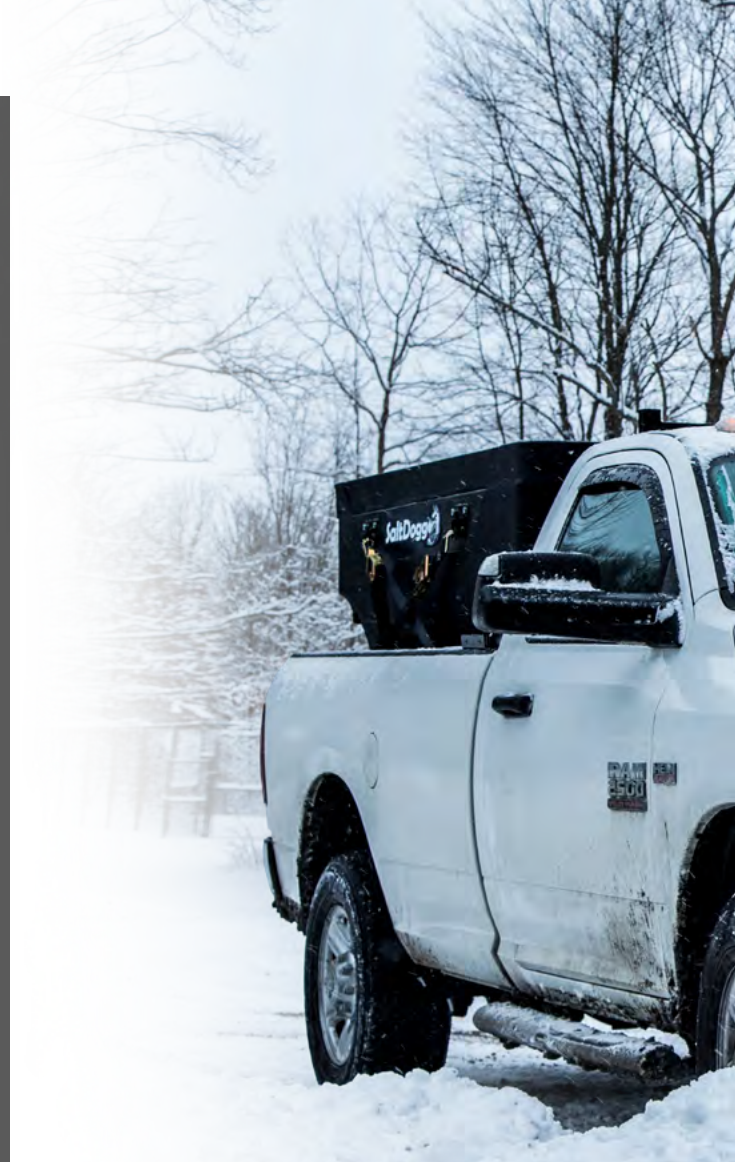



Shown with HX High Intensity Halogens
Also available with Illuminator™ Heated LED Plow Lights

RapidLink™ Attachment System

Mount and dismount the plow in a minute or less. See page 12 for details.

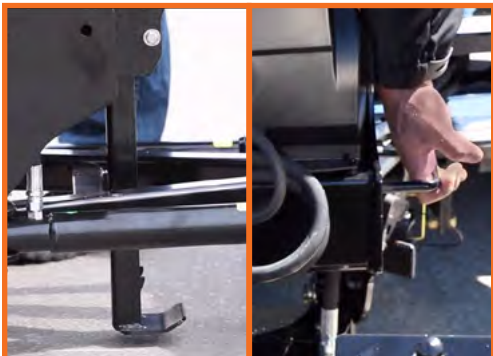

Optional Wings - Part No. I 16021310

Add a full 2' of width to your plow with the TE Series Plow Wing Kit.



VXF^{III}

Commercial Duty V Plow

3/4 Ton Trucks with Plow Prep, 1 Ton Trucks and Up

STANDARD FEATURES

Trip Edge Design

Allows for plowing over obstacles. Great for gravel, dirt, or uneven roads.

Standard Double Acting Angle Cylinders

Back drag with ease.

Floating A-Frame™

Contour the road for clean scraping and even cutting edge wear.

Municipal Style Chain Lift

Stack high and adjust easily.

Fully Enclosed Hydraulic Power Unit

Gain easy access via large maintenance panel.

304 Stainless Steel Moldboard & 1/2" Steel Cutting Edge

An investment that will last.

INCLUDED ACCESSORIES

Contoured Poly Snow Deflector

Wire Reinforced Blade Guides

Backlit Controller

Switch from V to scoop or angled positions with one button, or maintain independent wing control for finer adjustments.



Available Sizes
8'6", 9'6"



Shown with HX High Intensity Halogens
Also available with Illuminator™ Heated LED Plow Lights

RapidLink™ Attachment System

Mount and dismount the plow in a minute or less. See page 12 for details.

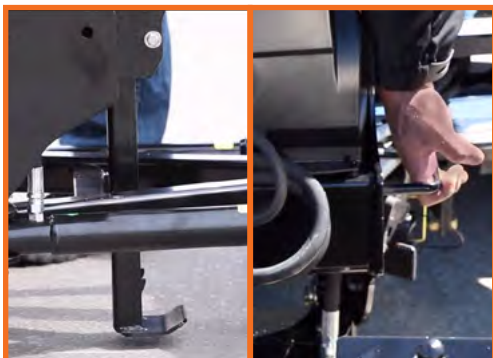

Optional Wings - Part No. I 16021712

Add a full 2' of width to your plow with the VXF Series Plow Wing Kit.



VXXIII

Commercial / Municipal Duty V Plow

Class 4, 5, and 6 Trucks

STANDARD FEATURES

Trip Edge Design

Allows for plowing over obstacles. Great for gravel, dirt, or uneven roads.

Standard Double Acting Angle Cylinders

Back drag with ease.

Heavy-Duty Floating A-Frame™

Contour the road for clean scraping and even cutting edge wear.

Designed to Take on the Big Jobs

1/2" thick trip angles and a 1-1/4" diameter center hinge pin provide unparalleled strength.

Municipal Style Chain Lift

Stack high and adjust easily.

Fully Enclosed Hydraulic Power Unit

Gain easy access via large maintenance panel.

304 Stainless Steel Moldboard & 5/8" Steel Cutting Edge

An investment that will last.

INCLUDED ACCESSORIES

Contoured Poly Snow Deflector

Wire Reinforced Blade Guides

Backlit Controller

Switch from V to scoop or angled positions with one button, or maintain independent wing control for finer adjustments.



Available Sizes
10'6"





Shown with Illuminator™
Heated LED Plow Lights

RapidLink™ Attachment System

Mount and dismount the plow in a minute or less. See page 12 for details.

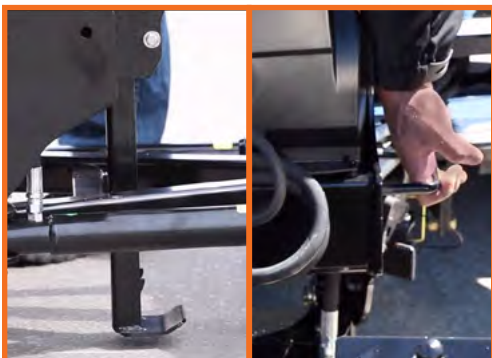

Municipal Style Chain Lift

Stack high and adjust easily.



Structurally Reinforced

1/2" thick trip angles and a 1-1/4" diameter center hinge pin provide unparalleled strength.



XP III

Independent Hydraulic Wings Expand from 8 - 10 Feet

3/4 Ton and Heavier Trucks

STANDARD FEATURES

True 10' Wide Scoop

For efficient snow control and clearing.

Adjustable Flared Wings

Can be operated independently for superior windrowing and maneuverability.

Nine Laser Cut Steel Ribs

Provide reliable strength.

Floating A-Frame

Contour the road for a clean scrape and even cutting edge wear.

Fully Enclosed Hydraulic Power Unit

Gain easy access via large maintenance panel.

304 Stainless Steel Moldboard & 1/2" Steel Cutting Edge

An investment that will last.

INCLUDED ACCESSORIES

Contoured Belted Rubber Snow Deflector

Cast Shoes

Wire Reinforced Blade Guides

Heavy Duty Shock Kit

In-Cab Controller

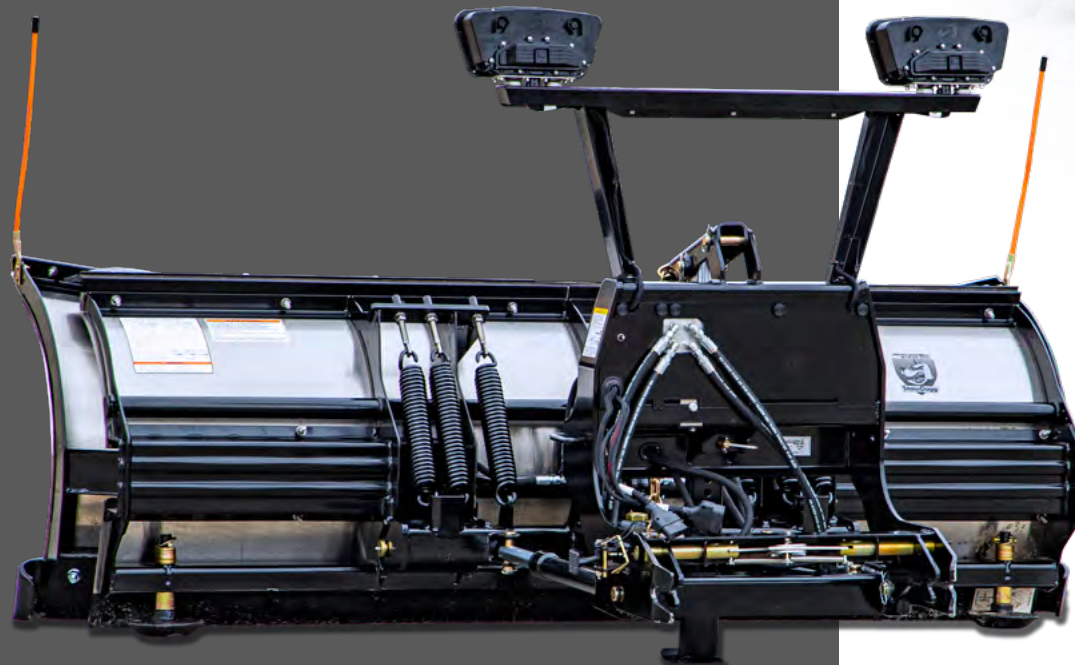

Expands
8' - 10'



Shown with Illuminator™
Heated LED Plow Lights

Ultimate Versatility

Retract/expand one or both flared wings at the press of a button to efficiently maneuver, windrow, and clear snow.

<p>Fully Retracted: Wings fully retracted for easy transportation between jobs.</p>	<p>Fully Extended: Wings fully extended in 10 ft scoop position for maximum snow clearing power.</p>	<p>Half Extended: Wings can operate individually for optimal maneuverability and windrowing.</p>

CM

Commercial / Municipal Plow

For Vehicles with 10,000 - 29,000 GVWR

STANDARD FEATURES

31" High / 108" or 120" or 132" Wide Moldboard

Makes the CM a powerful snow mover for commercial and municipal applications.

10 Vertical and 2 Diagonal Ribs

Create robust strength to handle heavy, wet snow.

Heavy-Duty Floating A-Frame™

Contour the road for clean scraping and even cutting edge wear.

304 Stainless Steel Moldboard & 5/8" Steel Cutting Edge

An investment that will last.

6 Stress-Optimized Trip Springs

Provide up to 85° of smooth full-moldboard trip action.

Central Hydraulic-Operated Lift Frame Available

INCLUDED ACCESSORIES

Heavy Duty Belted Rubber Snow Deflector

Wire Reinforced Blade Guides

Cast Plow Shoes

Controller



Available Sizes
9', 10', 11'



Shown with Illuminator™
Heated LED Plow Lights

RapidLink™ Attachment System

Mount and dismount the plow in a minute or less. See page 12 for details.

2" x 12" Angle Cylinder

Delivers greater angling force than standard cylinders.

Heavy Duty Lift Arm and Cylinder

Lift arm with heavy duty 2" x 6" lift cylinder provides exceptional snow stacking.

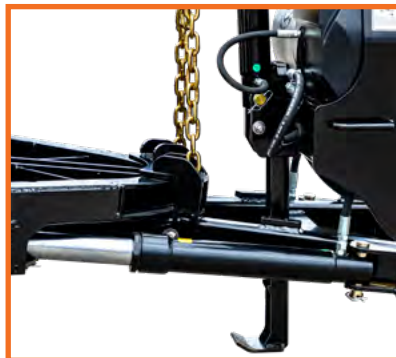
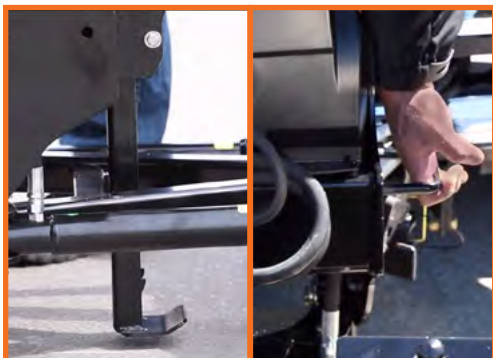

VUT / MUT

Hydraulically-Controlled Plows Specifically Designed for UTV Applications

Ideal for Sidewalks, Parks, and Campuses

STANDARD FEATURES

Weight Optimized for UTVs

Get the power of a SnowDogg® commercial plow that will fit most full-size UTVs.

Fast-Acting Hydraulic Power Unit

Hydraulic angle, lift, and wing control for UTV plows.

304 Stainless Steel Moldboard & 1/4" Steel Cutting Edge*

An investment that will last.

Narrow Width at Angle

Available at a minimum of 63" with blade at angle.

Full Trip (MUT) or Trip Edge (VUT) Design

Feel confident, even when you can't see what's below the snow.

**3/8" Steel Cutting Edge on MUT68*

VUT SPECIFIC FEATURES

Double Acting Angle Cylinders

Back drag with ease.

Flared Wings

Throw snow powerfully.

Narrow Width at "V" position

VUT65 has a 60" width in "V" position for narrow sidewalks.

INCLUDED ACCESSORIES

Wire Reinforced Blade Guides

Controller

Single hand operation.

Available Sizes

VUT - 6'

MUT - 6', 6'8"





Power Unit / Hydraulics

Equipped with full size SAE cartridge valves, oversized rubber hoses, and integral valve manifold.

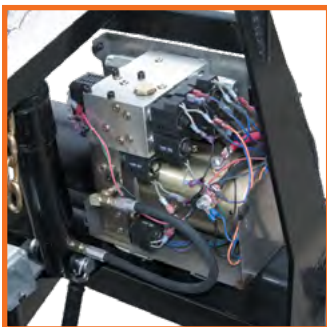

Angle Cylinders

Standard 1-1/2" x 8" double acting angle cylinders allow for real back dragging.



SKTE

Skid Steer Plows with Hydraulic Angling and Trip Edges

Universal Skid Steer Mount

STANDARD FEATURES

Universal Skid Steer Mount

Easily mount to any skid steer.

Hydraulic Angle Cylinders

Work with skid steers' existing hydraulic lines for responsive maneuverability.

Trip Edge Design

To respond to hidden divots and obstacles.

304 Stainless Steel Moldboard & 1/2" Steel Cutting Edge

An investment that will last.

INCLUDED ACCESSORIES

Contoured Poly Snow Deflector

Wire Reinforced Blade Guides

Cast Plow Shoes

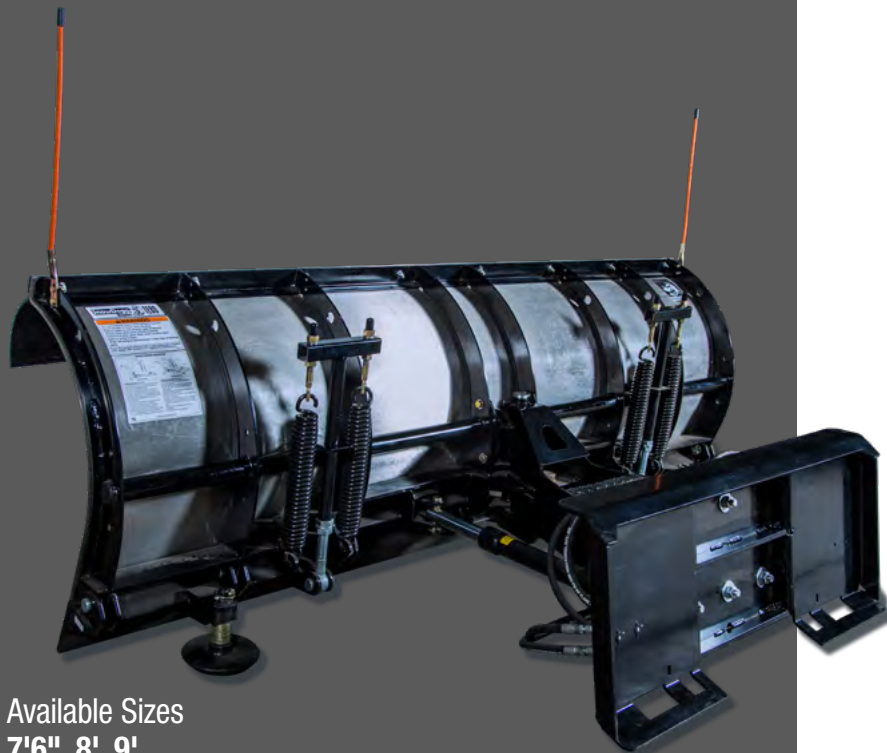

Available Sizes
7'6", 8', 9'



Trip Edge Design

Provides smoother plowing over obstacles.



1-1/2" x 12" Angle Cylinders

High angling force for handling heavy snow.



Optional Wings - Part No. I 16021310

Add a full 2' of width to your plow with the TE Series Plow Wing Kit.

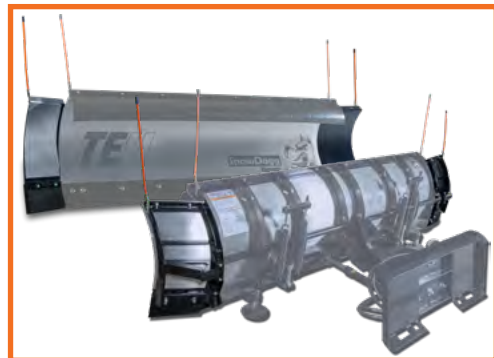

SKID-STEER / COMPACT SERIES PUSHERS

Minimum Required Machine Weight of 5,500 lb / 2,500 lb

Minimum Required Horsepower of 46 HP / 30 HP

STANDARD FEATURES

Durable Tuff-Kote™ Finish

Corrosion resistant powder coat doubles the life of your pusher.

Dual 4" Channels

Durable support where it's needed most.

AR400 Wear Shoes

Abrasion resistant steel provides superior wear life.

Universal Quick-Coupler Attachment

Versatile and easy attachment and removal.

Heavy Duty Precision-Rolled Moldboard

Enhanced snow rolling for a better quality push.

SKID-STEER SERIES SPECIFIC FEATURES

Premium Rubber Compound Cutting Edge

1" x 8" cutting edge slices through snow and ice.

Extreme-Duty Wear Shoes

5" x 3/4" wear shoes are made of AR400 steel for far greater wear life.

COMPACT SERIES SPECIFIC FEATURES

Premium Rubber Compound Cutting Edge

1" x 6" cutting edge slices through snow and ice.

Extreme-Duty Wear Shoes

3" x 3/4" wear shoes are made of AR400 steel for far greater wear life.



Available Sizes
8', 10', 12'

Available Sizes
6', 8', 10'



SKID-STEER SERIES SPECIFIC FEATURES

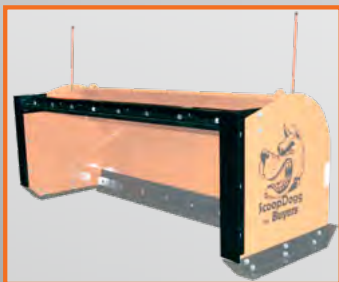

Optional Back Drag Kits

Include a 1" x 6" rubber cutting edge mounted to a black powder coat steel frame & a set of 3/4" thick abrasion resistant steel wear shoes. Used to pull snow away from buildings, docks and other tight places. The kit is bolt-on & removable.



7 Ga Rolled Steel Moldboard

with 5/16" thick side plates

COMPACT SERIES SPECIFIC FEATURES



Rubber Edge

3/8" x 3" rubber edge mounting bracket, 1" x 6" premium rubber edge, 5/8-11, grade 5 carriage bolts



10 Ga Rolled Steel Moldboard

with 1/4" thick side plates

LOADER SERIES PUSHERS

Minimum Required Machine Weight of 13,000 lb

Minimum Required Horsepower of 100 HP

STANDARD FEATURES

Durable Tuff-Kote™ Finish

Corrosion resistant powder coat doubles the life of your pusher.

Extreme Duty 12" H-Beam Design

Dependable strength where it's needed most.

Inside Posts with 3/8" Side Plates

Protect the equipment from impact damage.

Fully-Welded Lower Posts

Keeps the post higher off the ground to prevent damage from roll back.

AR400 Wear Shoes

Abrasion resistant steel provides superior wear life.

Premium Rubber Compound Cutting Edge

1-1/2" x 10" cutting edge slices through snow and ice.

AVAILABLE ACCESSORIES

8' Chain/Binder Kit - Part No. 9151008

10' Chain/Binder Kit - Part No. 9151010



Available Sizes

12', 14', 16', 18', 20'



7 Ga Rolled Steel Moldboard
with 3/8" thick side plates



Rubber Edge
3/8" x 4" rubber edge mounting bracket, 1-1/2" x 10" premium rubber edge, 5/8-11, grade 5 carriage bolts



Reinforced Support
4" x 4" 3/16" lower posts and 3" x 4" x 3/16" upper posts with 72" wide x 4.5" tall post spacing



BACKHOE SERIES PUSHERS

Minimum Required Machine Weight of 12,000 lb

Minimum Required Horsepower of 50 HP

STANDARD FEATURES

Durable Tuff-Kote™ Finish

Corrosion resistant powder coat doubles the life of your pusher.

Extreme Duty 12" H-Beam Design

Dependable strength where it's needed most.

Inside Posts with 3/8" Side Plates

Protect the equipment from impact damage.

Fully-Welded Lower Posts

Keeps the post higher off the ground to prevent damage from roll back.

AR400 Wear Shoes

Abrasion resistant steel provides superior wear life.

Premium Rubber Compound Cutting Edge

1-1/2" x 10" cutting edge slices through snow and ice.

AVAILABLE ACCESSORIES

8' Chain/Binder Kit - Part No. 9151008

10' Chain/Binder Kit - Part No. 9151010



Available Sizes
10', 12', 14'



7 Ga Rolled Steel Moldboard
with 3/8" thick side plates



Rubber Edge
3/8" x 4" rubber edge mounting bracket, 1-1/2" x 10" premium rubber edge, 5/8-11, grade 5 carriage bolts



Reinforced Support
4" x 4" 3/16" lower posts and 3" x 4" x 3/16" upper posts with 68" wide x 4.5" tall post spacing



OFFICIAL SNOWDOGG® ACCESSORIES

Cutting Edges

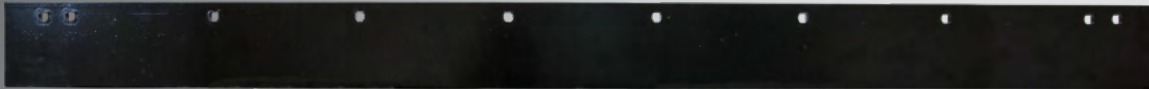

Steel Cutting Edge

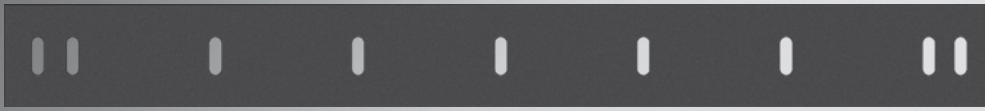

Rubber Cutting Edge

Part No.	Description	Part No.	Description	Part No.	Description
16120506	Cutting Edge, 72" x 1/4" (MUT60)	16120664	Cutting Edge, 132" x 5/8" (CM110)	16120840	Center Cutting Edge, V-Plow DS
16120510	Cutting Edge, 80" x 3/8"	16120705	Cutting Edge, 80" Rubber	16120842	Center Cutting Edge, VUT DS
16120520	Cutting Edge, 90" x 3/8"	16120710	Cutting Edge, 90" Rubber	16120852	Center Cutting Edge, VUT PS
16120530	Cutting Edge, 96" x 3/8"	16120720	Cutting Edge, 96" Rubber	16120850	Center Cutting Edge, V-Plow PS
16120610	Cutting Edge, 90" x 1/2"	16120730	Cutting Edge, 102" Rubber	16120860	Cutting Edge, VUT
16120620	Cutting Edge, 96" x 1/2"	16120740	Cutting Edge, 108" Rubber	16120870	Cutting Edge, VXX105
16120630	Cutting Edge, 102" x 1/2"	16120810	Cutting Edge, 34" x 3/8", VMX75	16120920	Cutting Edge, 90" x 1/2", XP810
16120640	Cutting Edge, 108" x 1/2"	16120811	Cutting Edge, 34" x 1/2", VMX75	16120940	Wing Cutting Edge, XP810 DS
16120660	Cutting Edge, 108" x 5/8" (CM90)	16120820	Cutting Edge, 40" x 1/2", VXF85	16120950	Wing Cutting Edge, XP810 PS
16120662	Cutting Edge, 120" x 5/8"	16120830	Cutting Edge, 46" x 1/2", VXF95		

Rubber Deflectors



Back Drag Edges

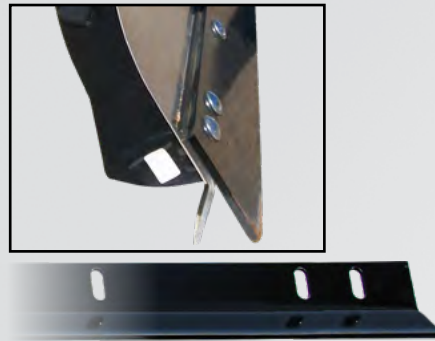

Maintenance



16109020

Part No.	Description	Part No.	Description	Part No.	Description
16120157	Deflector, 90" Rubber	16124010	Back Drag Edge, MD68	16109020	Emergency Kit for Straight Blade Plow
16120159	Deflector, 96" Rubber	16124020	Back Drag Edge, 7.5' MD/HD/EX	16109030	Emergency Kit for V-Plow
16120161	Deflector, 102" Rubber	16124030	Back Drag Edge, 8' MD/HD/EX	16150010	Hydraulic Fluid, 12 QTS Case
16120163	Deflector, 108" Rubber	16124040	Back Drag Edge, 8.5' EX85		
16120164	Deflector, 120" Rubber	16124050	Back Drag Edge, 9' EX90		
16120165	Deflector, 132" Rubber (CM110)	16124060	Back Drag Edge (Pair), VXF85		
16120171*	Deflector, VXF85, Rubber	16124070	Back Drag Edge (Pair), VXF90		
16120173*	Deflector, VXF95, Rubber	16124080	Back Drag Edge (Pair), VMX75		
16120180	VXF Rubber Kit				

*V-plows need two deflectors

Chain/Binder Kits

Part No.	Description
9151008*	8' Chain/Binder Kit
9151010*	10' Chain/Binder Kit

Illuminated LED Guides



1308124 Shown on VXF95II



- Patented light-up design makes it easier to see your equipment in low visibility conditions
- Includes wiring harness that is 12 ft per side with a pre-terminated male bullet connector and ring terminal to connect to the LED guides
- Unique, eye-catching look helps your truck stand out from the competition
- Easy wiring and installation that only requires a few basic tools
- Compatible with most snow plows and truck bumpers

Part No.	Description
1308124	24 Inch Illuminated LED Snow Plow Blade Guides
1308128	28 Inch Illuminated LED Snow Plow Blade Guides
1308136	36 Inch Illuminated LED Snow Plow Blade Guides



Our History



1946 Buyers Products Company founded by Sam Ruven and Bessie Kleinman as a distributor of driveline components.



Buyers continued to grow its product offerings and build valued relationships with customers and suppliers. Increased demand for products led to the pursuit of supply chain manufacturing solutions.



1992 Buyers acquired Trailer Components Manufacturing (Tracom) for CNC precision machining and tooling, as well as state-of-the-art welding.



1995 Buyers acquired Progressive Powder Coating. Our Nordson automatic powder application booth is used to powder coat our Buyers toolboxes and other truck and trailer accessories.



2002 Buyers moved its corporate headquarters to a brand new 235,000 sq. ft. state-of-the-art office and distribution center.



2004 Buyers acquired Romotech in New Paris, Indiana. Our Ferry Industries Rotospeed molding machines are used to manufacture our poly salt spreaders.



2007 Buyers began manufacturing the SnowDogg stainless steel snowplow at our Mentor, Ohio facility.



2009 Buyers began our operations at Boomerang Rubber, in Botkins, Ohio manufacturing mudflaps, wheel chocks and other rubber truck and trailer accessories.



2013 Buyers acquired an additional 500,000 sq.ft. manufacturing facility in Mentor, Ohio allowing for expansion of our aluminum and stainless steel manufacturing.



2016 Buyers establishes a 22,000 sq ft Engineering Tech Center in Mentor, Ohio. It's multi-use lab, design, training and prototyping space is dedicated to the research and development of innovative product.

ALL YOUR WORK TRUCK PRODUCTS ALL THE TIME.

2017 Buyers launches new website with business partner portal, to make online ordering and account maintenance easy for customers.



2021 Buyers adds almost 300,000 sq ft of additional, state-of-the-art warehouse and office space to maintain the quick turnaround and competitive value their customers expect.



Fiercely Independent Since 1946

Buyers Products is a **fully integrated manufacturer** and a leader in the truck equipment industry, headquartered in Northeast Ohio.

Buyers Products' mission is to improve our Customers' profitability and productivity while enhancing the quality of our products and services.



NOTHING WORKS LIKE A DOGG™



www.buyersproducts.com



LITFLOW_K