



TRUCK TOOL BOXES



ALL NEW
CAM LOCK BOXES
See pg. 26

PLUS NEW
Tunnel Boxes
See pg. 68

NOTHING WORKS LIKE A DOGG™

Our History



1946
Buyers Products Company founded by Sam Ruven and Bessie Kleinman as a distributor of driveline components.

Tacom

1992 Buyers acquired Trailer Components Manufacturing (Tacom) for CNC precision machining and tooling, as well as state-of-the-art welding.

Buyers

Buyers continued to grow its product offerings and build valued relationships with customers and suppliers. Increased demand for products led to the pursuit of supply chain manufacturing solutions.

PROGRESSIVE POWDER COATING, INC.

1995 Buyers acquired Progressive Powder Coating. Our Nordson automatic powder application booth is used to powder coat our Buyers toolboxes and other truck and trailer accessories.

Buyers

2002 Buyers moved its corporate headquarters to a brand new 235,000 sq. ft. state-of-the-art office and distribution center.

Romotech

2004 Buyers acquired Romotech in New Paris, Indiana. Our Ferry Industries Rotospeed molding machines are used to manufacture our poly salt spreaders.

SnowDogg

2007 Buyers began manufacturing the SnowDogg stainless steel snowplow at our Mentor, Ohio facility.

Boomerang RUBBER, INC.

2009 Buyers began our operations at Boomerang Rubber, in Botkins, Ohio manufacturing mudflaps, wheel chocks and other rubber truck and trailer accessories.

Buyers

2013 Buyers acquired an additional 500,000 sq. ft. manufacturing facility in Mentor, Ohio allowing for expansion of our aluminum and stainless steel manufacturing.

SaltDogg

Buyers

2016 Buyers establishes a 22,000 sq ft Engineering Tech Center in Mentor, Ohio. It's multi-use lab, design, training and prototyping space is dedicated to the research and development of innovative product.

ALL YOUR WORK TRUCK PRODUCTS ALL THE TIME.

2017 Buyers launches new website with business partner portal, to make online ordering and account maintenance easy for customers.

Buyers

2021 Buyers adds almost 300,000 sq ft of additional, state-of-the-art warehouse and office space to maintain the quick turnaround and competitive value their customers expect.

Our Corporate Family of Companies



Founded in 1946, Buyers Products is a fully integrated manufacturer and a leader in the truck equipment industry. Our engineering, manufacturing and assembly operations take place in the USA, under the Buyers family of companies. **Buyers Products' mission is to improve our Customers' profitability and productivity while enhancing the quality of our products and services.**





UNDERBODY 4-35

- PRO Series Steel..... 6-9
- Steel 10-19
- PRO Series Aluminum..... 20-25
- Cam Box Aluminum 26-27
- Aluminum 28-32
- Polymer 33
- Mounting Brackets..... 34-35

TOPSIDER 36-45

- PRO Series Steel..... 38
- Steel 39
- Aluminum 40-45

BACKPACK 46-67

- Four Door Offset, Aluminum 48-49
- Four Door Offset, Steel 50-51
- Four Door Flat, Aluminum 52-53
- Four Door Flat, Steel 54-55
- Two Door Offset..... 56-57
- Two Door Flat..... 58-59
- L-Pack..... 60-61
- Underbody Boxes 62-63
- Accessories..... 64-67

TUNNEL BOXES 68-71

IN-BED STORAGE..... 72-83

- Crossover 74-75
- Gull Wing..... 76-77
- Lo-Sider..... 78-79
- Storage Chests 80-83

TRAILER TONGUE 84-86

CLASS 8 BOXES 86-89

PARTS & ACCESSORIES 90-94

DISPLAYS..... 95

REPLACEMENT PARTS..... 96-97

INDEX 98-99

PRODUCT HIGHLIGHTS:

NEW TUNNEL BOXES

pg. 71



COMPLETELY REDESIGNED GULL WING SERIES

pg. 76



NEW ALUMINUM UNDERBODY with CAM LOCK HARDWARE

pg. 26





UNDE



UNDERBODY

PRO SERIES STEEL TRUCK TOOL BOXES

MAXIMUM DURABILITY MAXIMUM PROTECTION



1752805
18x18x36 Drop Down

PRO SERIES DURABILITY



12 Gauge steel with cross break in door for added strength

PRO SERIES PROTECTION



Rain gutter with automotive bulb seal keeps gear dry

PRO SERIES SECURITY



Maximum door security with heavy duty 3/16" door chains

PRO SERIES RELIABILITY



Corrosion resistant stainless steel bolt-on hinge

ALL THE FEATURES A *PRO* WOULD DEMAND

PRO SERIES UNDERBODY



VS

STANDARD UNDERBODY



Maximum Material Thickness **12 Gauge Steel**

Maximum Weather Protection **Rain Gutter with Automotive Bulb Seal**

Maximum Door Security **3/16" Door Chains**

Hinge **Stainless Steel Bolt-On Hinge with a 1/4" Pin**

Door **Offset Door**

Material Thickness 14 Gauge Steel

Weather Protection Weather Resistant Seal

Door Security Steel Wire Lanyards with PVC Coating

Hinge Stainless Steel Bolt-On Hinge

Door Recessed Door

PRO Series Steel Underbody

- 12 gauge steel box and cross-broke door
- Removable door design
- Automotive D-bulb seal
- Stainless steel bolt-on continuous hinge with oversized 1/4" pin
- Built-in rain gutter
- Detachable 3/16" door chains
- Locking die cast T-handle compression latch

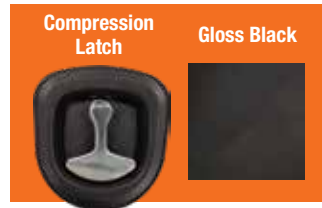

Gloss Black, Single Latch



Part No.	Height	Depth	Width	# Latches per Door	Wt. (lb)	Cat.
1752799	18	18	18	1	56	530 (Y)
1752800	18	18	24	1	80	530 (Y)
1752803	18	18	30	1	91	530 (Y)
1752805	18	18	36	1	104	530 (Y)
1752810	18	18	48	1	127	530 (Y)
1754800	24	24	24	1	90	530 (Y)
1754803	24	24	30	1	115	530 (Y)
1754805	24	24	36	1	132	530 (Y)
1754807	24	24	48	1	145	530 (Y)

Gloss Black, Double Door

Works great as Topsider on flatbeds and service bodies.



Part No.	Height	Depth	Width	# Latches per Door	Wt. (lb)	Cat.
1752815†	18	18	60	1	175	530 (Y)
1752825†	18	18	72	1	202	530 (Y)
1752835†	18	18	90	1	228	530 (Y)
1752836†	18	18	96	1	250	530 (Y)
1754809†	24	24	60	1	160	530 (Y)
1754811†	24	24	72	1	175	530 (Y)
1754814†	24	24	90	1	190	530 (Y)
1754817†	24	24	96	1	210	530 (Y)

†Boxes can be used as topsiders and underbodies



See pg. 34-35 for Underbody Mounting Brackets

Steel Underbodies



Steel Features



Bolt-on, stainless steel continuous hidden hinge



Replaceable gasket sealing system

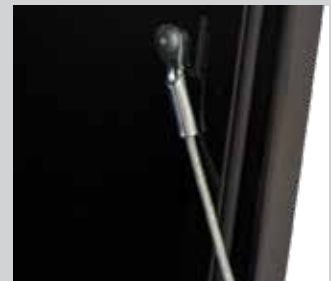

Aircraft grade door cables

T-HANDLE LATCH

- 14 gauge powder-coated steel box
- Drop-down recessed door
- Locking stainless steel T-handle latches
- Bolt-on, stainless steel continuous hidden hinge
- Replaceable gasket sealing system
- Aircraft grade door cables
- Reinforced door backbone on boxes 48" and wider
- Door opening: flat surface mount (90°) or underbody mount (180°)



Gloss Black, Single Latch



Part No.	Height	Depth	Width	# Latches per Door	Wt. (lb)	Cat.
1703349	14	12	18	1	37	530 (Y)
1703350	14	12	24	1	40	530 (Y)
1703353	14	12	30	1	49	530 (Y)
1703300	14	16	24	1	56	530 (Y)
1703303	14	16	30	1	65	530 (Y)
1703305	14	16	36	1	74	530 (Y)
1703310	15	10	15	1	28	530 (Y)
1703312	15	10	24	1	39	530 (Y)
1703320	15	13	15	1	32	530 (Y)
1703321	15	13	18	1	38	530 (Y)
1703322	15	13	24	1	45	530 (Y)
1703324	15	13	30	1	53	530 (Y)
1703326	15	13	36	1	61	530 (Y)
1703330	16	14	18	1	50	530 (Y)
1702295	18	18	18	1	47	530 (Y)
1702300	18	18	24	1	67	530 (Y)
1702303	18	18	30	1	80	530 (Y)
1702305	18	18	36	1	92	530 (Y)
1704300	24	24	24	1	87	530 (Y)
1704303	24	24	30	1	100	530 (Y)
1704305	24	24	36	1	116	530 (Y)

Gloss Black, Dual Latch



Part No.	Height	Depth	Width	# Latches per Door	Wt. (lb)	Cat.
1703328	15	13	48	2	83	530 (Y)
1702310	18	18	48	2	118	530 (Y)
1702315	18	18	60	2	143	530 (Y)
1702317	18	18	66	2	186	530 (Y)
1708310	18	24	48	2	133	530 (Y)
1704310	24	24	48	2	145	530 (Y)
1704315	24	24	60	2	175	530 (Y)

Gloss Black, Double Door



Part No.	Height	Depth	Width	# Latches per Door	Wt. (lb)	Cat.
1702325†	18	18	72	1	156	530 (Y)
1704320†	24	24	72	1	165	530 (Y)

†Boxes can be used as topsiders and underbodies

Steel Underbody

Gloss White, Single Latch



Part No.	Height	Depth	Width	# Latches per Door	Wt. (lb)	Cat.
1703400	14	16	24	1	56	530 (Y)
1703403	14	16	30	1	65	530 (Y)
1703405	14	16	36	1	71	530 (Y)
1703495	18	18	18	1	47	530 (Y)
1702400	18	18	24	1	67	530 (Y)
1702403	18	18	30	1	80	530 (Y)
1702405	18	18	36	1	92	530 (Y)
1704400	24	24	24	1	87	530 (Y)
1704403	24	24	30	1	100	530 (Y)
1704405	24	24	36	1	116	530 (Y)

Gloss White, Dual Latch



Part No.	Height	Depth	Width	# Latches per Door	Wt. (lb)	Cat.
1702410	18	18	48	2	118	530 (Y)
1702415	18	18	60	2	143	530 (Y)
1702417	18	18	66	2	186	530 (Y)
1708410	18	24	48	2	133	530 (Y)
1704410	24	24	48	2	145	530 (Y)
1704415	24	24	60	2	168	530 (Y)

Gloss White, Double Door



Part No.	Height	Depth	Width	# Latches per Door	Wt. (lb)	Cat.
1702425	18	18	72	1	133	530 (Y)
1704420	24	24	72	1	165	530 (Y)

Primed, Single Latch



Part No.	Height	Depth	Width	# Latches per Door	Wt. (lb)	Cat.
1703900	14	16	24	1	56	530 (Y)
1702905	18	18	36	1	92	530 (Y)

Primed, Dual Latch



Part No.	Height	Depth	Width	# Latches per Door	Wt. (lb)	Cat.
1702910	18	18	48	2	118	530 (Y)

T-HANDLE OR 3-POINT COMPRESSION LATCH WITH WELDED SHELF

- 14 gauge steel box
- 14 gauge steel shelf welded at mid height, 12-3/4" deep with 1" front lip
- Locking T-handle or 3-point compression latches
- Replaceable gasket sealing system

T-Handle Latch & Aircraft Grade Door Cables



Part No.	Height	Depth	Width	# Latches per Door	Wt. (lb)	Cat.
1703304	14	16	30	1	72	530 (Y)

Compression Latch



Part No.	Height	Depth	Width	# Latches per Door	Wt. (lb)	Cat.
1702306†	18	18	36	1	82	530 (Y)
1702311†	18	18	48	1	106	530 (Y)

† Without lanyards

T-HANDLE LATCH WITH SLANTED BACK

- Angled top allows room for fuel fill hoses on single rear wheel flat beds
- Locking stainless steel T-handle latches
- Door opening: flat surface mount (90°) or underbody mount (180°)
- Drop-down recessed door
- Replaceable gasket sealing system

Gloss Black



Part No.	Height	Depth	Width	# Latches per Door	Wt. (lb)	Cat.
1703351	14	12	18	1	40	530 (Y)
1703352	14	12	24	1	47	530 (Y)
1703355	14	12	30	1	49	530 (Y)

Steel Underbody

PADDLE LATCH

- 14 gauge powder-coated steel box
- Drop-down recessed door
- Locking stainless steel paddle latch
- Bolt-on continuous hidden hinge
- Replaceable gasket sealing system
- Aircraft grade door cables
- Reinforced door backbone on boxes 48" and wider
- Door opening: flat surface mount (90°) or underbody mount (180°)



Gloss Black, Single Latch



Part No.	Height	Depth	Width	# Latches per Door	Wt. (lb)	Cat.
1703150	14	12	24	1	48	530 (Y)
1703100	14	16	24	1	56	530 (Y)
1703103	14	16	30	1	65	530 (Y)
1702100	18	18	24	1	67	530 (Y)
1702103	18	18	30	1	80	530 (Y)
1702105	18	18	36	1	92	530 (Y)

Gloss Black, Dual Latch



Part No.	Height	Depth	Width	# Latches per Door	Wt. (lb)	Cat.
1702110	18	18	48	2	118	530 (Y)
1702115	18	18	60	2	143	530 (Y)

Gloss White, Single Latch



Part No.	Height	Depth	Width	# Latches per Door	Wt. (lb)	Cat.
1703203	14	16	30	1	65	530 (Y)
1703205	14	16	36	1	74	530 (Y)
1702200	18	18	24	1	67	530 (Y)
1702203	18	18	30	1	80	530 (Y)
1702205	18	18	36	1	92	530 (Y)

Gloss White, Dual Latch



Part No.	Height	Depth	Width	# Latches per Door	Wt. (lb)	Cat.
1702210	18	18	48	2	118	530 (Y)
1702215	18	18	60	2	143	530 (Y)

3-POINT COMPRESSION LATCH

- 14 gauge powder-coated steel box
- Drop-down recessed door
- Die-cast T-handle compression latch with 3-point locking system
- Bolt-on continuous hidden hinge
- Replaceable gasket sealing system
- Aircraft grade door cables
- Reinforced door backbone on boxes 48" and wider
- Door opening: flat surface mount (90°) or underbody mount (180°)



Gloss Black



Part No.	# Doors	Height	Depth	Width	# Latches per Door	Wt. (lb)	Cat.
1732300	1	18	18	24	1	59	530 (Y)
1732303	1	18	18	30	1	70	530 (Y)
1732305	1	18	18	36	1	83	530 (Y)
1732310	1	18	18	48	1	118	530 (Y)
1732315	1	18	18	60	1	143	530 (Y)
1732320	2	18	18	72	1	142	530 (Y)
1734300	1	24	24	24	1	84	530 (Y)
1734303	1	24	24	30	1	95	530 (Y)
1734305	1	24	24	36	1	110	530 (Y)
1704320	2	24	24	72	1	165	530 (Y)

Gloss White



Part No.	# Doors	Height	Depth	Width	# Latches per Door	Wt. (lb)	Cat.
1732400	1	18	18	24	1	59	530 (Y)
1732403	1	18	18	30	1	70	530 (Y)
1732405	1	18	18	36	1	83	530 (Y)
1732410	1	18	18	48	1	118	530 (Y)
1732415	1	18	18	60	1	143	530 (Y)
1702425	2	18	18	72	1	133	530 (Y)
1734400	1	24	24	24	1	84	530 (Y)
1734403	1	24	24	30	1	95	530 (Y)
1734405	1	24	24	36	1	110	530 (Y)
1704420	2	24	24	72	1	165	530 (Y)

Textured Matte Black



Part No.	Height	Depth	Width	# Latches per Door	Wt. (lb)	Cat.
1732500	18	18	24	1	59	530 (Y)
1732503	18	18	30	1	70	530 (Y)
1732505	18	18	36	1	83	530 (Y)
1732510	18	18	48	1	118	530 (Y)
1734500	24	24	24	1	84	530 (Y)
1734503	24	24	30	1	95	530 (Y)
1734505	24	24	36	1	110	530 (Y)

Steel Underbody

POLISHED STAINLESS STEEL DOOR WITH COMPRESSION LATCH

- 14 gauge steel or stainless box with polished 16 gauge stainless steel door
- Drop-down recessed door
- Locking die-cast T-handle compression latch
- Continuous hidden hinge
- Replaceable gasket sealing system
- Aircraft grade door cables
- Reinforced door backbone on boxes 48" and wider
- Door opening: flat surface mount (90°) or underbody mount (180°)



Gloss Black Box, Single Latch



Part No.	Height	Depth	Width	# Latches per Door	Wt. (lb)	Cat.
1703700	14	16	24	1	55	530 (Y)
1703703	14	16	30	1	64	530 (Y)
1703705	14	16	36	1	71	530 (Y)
1702965	18	18	18	1	42	530 (Y)
1702700	18	18	24	1	72	530 (Y)
1702703	18	18	30	1	81	530 (Y)
1702705	18	18	36	1	101	530 (Y)
1704700	24	24	24	1	70	530 (Y)
1704703	24	24	30	1	81	530 (Y)
1704705	24	24	36	1	132	530 (Y)

Gloss Black Box, Dual Latch



Part No.	Height	Depth	Width	# Latches per Door	Wt. (lb)	Cat.
1702710	18	18	48	2	110	530 (Y)
1702715	18	18	60	2	132	530 (Y)
1708710	18	24	48	2	108	530 (Y)
1704710	24	24	48	2	169	530 (Y)
1704715	24	24	60	2	227	530 (Y)

Gloss Black Box, Double Door



Part No.	Height	Depth	Width	# Latches per Door	Wt. (lb)	Cat.
1702725	18	18	72	1	156	530 (Y)

Stainless Box, Single Latch



Part No.	Height	Depth	Width	# Latches per Door	Wt. (lb)	Cat.
1702595	18	18	18	1	51.5	530 (Y)
1702600	18	18	24	1	61.5	530 (Y)
1702603	18	18	30	1	81	530 (Y)
1702605	18	18	36	1	85	530 (Y)

Stainless Box, Dual Latch



Part No.	Height	Depth	Width	# Latches per Door	Wt. (lb)	Cat.
1702610	18	18	48	2	110	530 (Y)



See pg. 34-35 for Underbody Mounting Brackets

Steel Underbody

MIRROR FINISH STAINLESS STEEL DOOR WITH COMPRESSION LATCH

- 16 gauge high polish steel box and door
- Drop-down external door
- Locking die-cast T-handle compression latch
- Continuous hidden hinge
- Replaceable door cables
- Built-in rain gutter with automotive bulb seal



Single Latch



Part No.	Height	Depth	Width	# Latches per Door	Wt. (lb)	Cat.
1702650	18	18	24	1	48	530 (N)
1702653	18	18	30	1	57	530 (N)
1702655	18	18	36	1	65	530 (N)

Dual Latch



Part No.	Height	Depth	Width	# Latches per Door	Wt. (lb)	Cat.
1702660	18	18	48	2	80	530 (N)



DIAMOND TREAD ALUMINUM DOOR WITH COMPRESSION LATCH

- 14 gauge steel box with .100" thick diamond tread door
- Drop-down recessed door
- Locking die-cast T-handle compression latch
- Bolt-on continuous hidden hinge
- Replaceable gasket sealing system
- Aircraft grade door cables
- Door opening: flat surface mount (90°) or underbody mount (180°)
- Reinforced door backbone on boxes 48" and wider



Gloss Black, Single Latch



Part No.	Height	Depth	Width	# Latches per Door	Wt. (lb)	Cat.
1702500	18	18	24	1	61	530 (Y)
1702503	18	18	30	1	72	530 (Y)
1702505	18	18	36	1	82	530 (Y)

Gloss Black, Dual Latch



Part No.	Height	Depth	Width	# Latches per Door	Wt. (lb)	Cat.
1702510	18	18	48	2	104	530 (Y)



See pg. 34-35 for Underbody Mounting Brackets

PRO SERIES
ALUMINUM TRUCK
TOOL BOXES

MAXIMUM DURABILITY
MAXIMUM PROTECTION



1706405
18x18x36 Drop Down

PRO SERIES DURABILITY

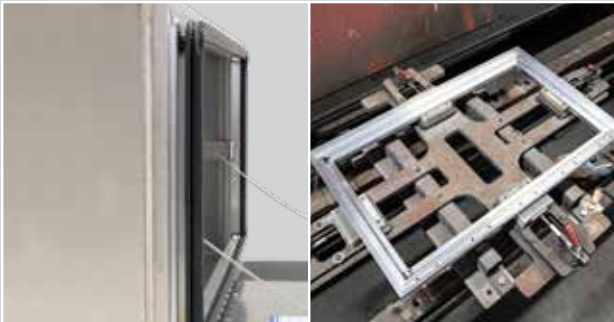

0.125" Aluminum with extruded door frame for maximum strength

PRO SERIES PROTECTION



Rain gutter with automotive bulb seal keeps gear dry

PRO SERIES SECURITY



Locking 3-Point compression latch keeps gear safe

PRO SERIES RELIABILITY



Corrosion resistant stainless steel bolt-on hinge



ALL THE FEATURES A *PRO* WOULD DEMAND

PRO SERIES UNDERBODY

STANDARD UNDERBODY

VS



Maximum Material Thickness	0.125" Aluminum with Extruded Door Frame
Maximum Security	Locking 3-Point Compression Latch
Maximum Weather Protection	Rain Gutter with Automotive Bulb Seal
Hinge	Stainless Steel Bolt-On Hinge with a 1/4" Pin
Door	Offset Door

Material Thickness	0.100" Aluminum
Security	Locking Compression Latch
Weather Protection	Weather Resistant Seal
Hinge	Aluminum Hinge
Door	Recessed Door

PRO Series Aluminum Underbody

DROP DOOR WITH 3-POINT COMPRESSION LATCH

- .125" thick smooth aluminum with rigid extruded box frame (.100" thick diamond tread aluminum door on certain models)
- Die-cast T-handle compression latch with 3-point locking system
- Stainless steel bolt-on continuous hinge with oversized 1/4" pin
- Built-in rain gutter with automotive bulb seal

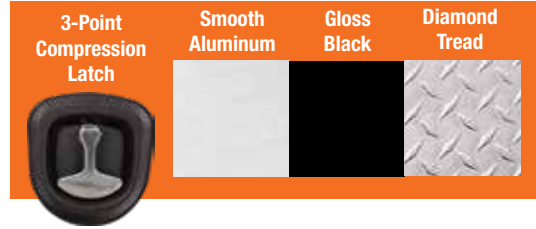

Smooth Aluminum



Part No.	Height	Depth	Width	# Latches per Door	Wt. (lb)	Cat.
1706400	18	18	24	1	44	530 (Y)
1706403	18	18	30	1	50	530 (Y)
1706405	18	18	36	1	57	530 (Y)
1706410	18	18	48	1	64	530 (Y)
1706415	18	18	60	1	78	530 (Y)
1706420	18	24	36	1	57	530 (Y)
1706425	18	24	48	1	79	530 (Y)
1706430	18	24	60	1	83	530 (Y)

Gloss Black



Part No.	Height	Depth	Width	# Latches per Door	Wt. (lb)	Cat.
1706960	18	18	24	1	44	530 (Y)
1706963	18	18	30	1	50	530 (Y)
1706965	18	18	36	1	57	530 (Y)
1706970	18	18	48	1	64	530 (Y)
1706975	18	18	60	1	78	530 (Y)
1706980	18	24	36	1	57	530 (Y)
1706985	18	24	48	1	79	530 (Y)
1706990	18	24	60	1	83	530 (Y)

PRO Series Aluminum Underbody

Diamond Tread Door



Part No.	Height	Depth	Width	# Latches per Door	Wt. (lb)	Cat.
1706500	18	18	24	1	41	530 (Y)
1706503	18	18	30	1	48	530 (Y)
1706505	18	18	36	1	56	530 (Y)
1706510	18	18	48	1	69	530 (Y)
1706515	18	18	60	1	79	530 (Y)



See pg. 34-35 for Underbody Mounting Brackets

PRO Series Aluminum Underbody

SMOOTH ALUMINUM BARN DOOR WITH COMPRESSION LATCH

- .125" thick smooth aluminum with rigid extruded box frame
- Locking die-cast T-handle compression latch
- 3 point locking system on double barn doors, standard lock system on single swing door
- Stainless steel bolt-on continuous hinge with oversized 1/4" pin
- Built-in rain gutter with automotive bulb seal
- Unobstructed box opening with no center post

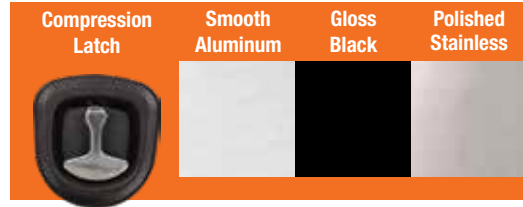

Smooth Aluminum



Part No.	Height	Depth	Width	# Doors	Wt. (lb)	Cat.
1705395	18	18	18	1	56.5	530 (Y)
1705401	18	18	24	1	56.5	530 (Y)
1705403	18	18	30	2	45	530 (Y)
1705405	18	18	36	2	51	530 (Y)
1705410	18	18	48	2	62	530 (Y)
1705415	18	18	60	2	73	530 (Y)
1705420	18	24	36	2	58	530 (Y)
1705425	18	24	48	2	71	530 (Y)
1705430	18	24	60	2	85	530 (Y)
1705431	24	24	24	1	67	530 (Y)
1705433	24	24	30	2	62	530 (Y)
1705435	24	24	36	2	67	530 (Y)
1705440	24	24	48	2	83	530 (Y)
1705445	24	24	60	2	99	530 (Y)
1705450	24	24	72	2	105	530 (Y)

Gloss Black



Part No.	Height	Depth	Width	# Doors	Wt. (lb)	Cat.
1705895	18	18	18	1	56.5	530 (Y)
1705900	18	18	24	1	56.5	530 (Y)
1705903	18	18	18	2	45	530 (Y)
1705903	18	18	30	2	45	530 (Y)
1705905	18	18	36	2	51	530 (Y)
1705910	18	18	48	2	62	530 (Y)
1705915	18	18	60	2	73	530 (Y)
1705920	18	24	36	2	58	530 (Y)
1705925	18	24	48	2	71	530 (Y)
1705930	18	24	60	2	85	530 (Y)
1705931	24	24	24	1	67	530 (Y)
1705933	24	24	30	2	62	530 (Y)
1705935	24	24	36	2	67	530 (Y)
1705940	24	24	48	2	83	530 (Y)
1705945	24	24	60	2	99	530 (Y)
1705950	24	24	72	2	105	530 (Y)

PRO Series Aluminum Underbody

Smooth Aluminum with Stainless Steel Doors



Part No.	Height	Depth	Width	# Doors	Wt. (lb)	Cat.
1705510*	18	18	36	2	56	530 (Y)
1705515*	18	18	48	2	69	530 (Y)
1705520*	18	18	60	2	91	530 (Y)
1705580*	24	24	48	2	93	530 (Y)
1705585*	24	24	60	2	119	530 (Y)

* **NEW** PRODUCTS



See pg. 34-35 for Underbody Mounting Brackets

Cam Lock Underbodies

ALL NEW



.125" thick smooth aluminum

1763103

Side-hinged doors with reversible right/left locking door

Stainless steel bolt-on continuous hinge with oversized 1/4" pin



Cam Lock Features



Side-hinged doors with reversible right/left locking door



Built-in rain gutter with automotive bulb seal



Stainless steel bolt-on continuous hinge with oversized 1/4" pin



Unobstructed box opening

BARN DOOR WITH CAM LATCH

- 0.125" thick smooth aluminum
- Unobstructed box opening with no center post
- Cam-Lock hardware is made of high-quality aluminum and allows for the use of a personal padlock (purchased separately)
- Designed for universal installation (drivers side or passenger side)
- Stainless steel bolt-on continuous hinge with oversized 1/4" pin
- Built-in rain gutter with automotive bulb seal
- Ideal for Flat Bed Trailer or Step Deck Applications

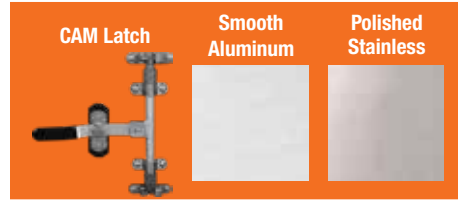

Smooth Aluminum Doors



Part No.	Height	Depth	Width	# Doors	Wt. (lb)	Cat.
1762600*	18	18	36	2	55	530 (Y)
1762603*	18	18	48	2	65	530 (Y)
1762606*	18	18	60	2	76	530 (Y)
1762609*	18	18	72	2	87	530 (Y)
1762621*	18	24	36	2	63	530 (Y)
1762624*	18	24	48	2	75	530 (Y)
1762627*	18	24	60	2	88	530 (Y)
1762630*	18	24	72	2	101	530 (Y)
1762639*	24	24	36	2	73	530 (Y)
1762642*	24	24	48	2	87	530 (Y)
1762645*	24	24	60	2	102	530 (Y)
1762648*	24	24	72	2	116	530 (Y)

Polished Stainless Steel Doors



Part No.	Height	Depth	Width	# Doors	Wt. (lb)	Cat.
1763103*	18	18	48	2	65	530 (Y)
1763106*	18	18	60	2	84	530 (Y)
1763124*	18	24	48	2	75	530 (Y)
1763127*	18	24	60	2	96	530 (Y)
1763142*	24	24	48	2	87	530 (Y)
1763145*	24	24	60	2	110	530 (Y)

* **NEW** PRODUCTS



See pg. 34-35 for Underbody Mounting Brackets

Aluminum Underbody

BARN DOOR WITH COMPRESSION LATCH

- 0.100" thick diamond tread or smooth aluminum
- Side-hinged doors with reversible right/left locking door
- Locking die-cast T-handle compression latch
- 3 point locking system on double barn doors, standard lock system on single swing door
- Aluminum bolt-on continuous hinge with oversize 1/4" pin
- Automotive D-bulb seal
- Can mount on flat surface
- Unobstructed box opening with no center post

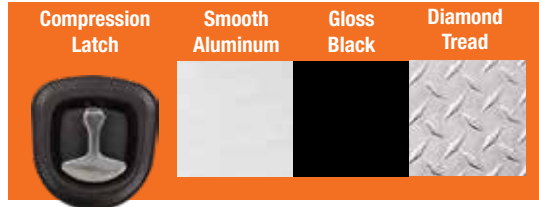

Smooth Aluminum



Part No.	Height	Depth	Width	# Doors	Wt. (lb)	Cat.
1705295	18	18	18	1	26	530 (Y)
1705300	18	18	24	1	32	530 (Y)
1705303	18	18	30	2	42	530 (Y)
1705305	18	18	36	2	49	530 (Y)
1705310	18	18	48	2	63	530 (Y)
1705315	18	18	60	2	77	530 (Y)
1705325	24	24	24	1	43	530 (Y)
1705333	24	24	30	2	69	530 (Y)
1705335	24	24	36	2	75	530 (Y)
1705340	24	24	48	2	87	530 (Y)
1705345	24	24	60	2	99	530 (Y)
1705350	24	24	72	2	98	530 (Y)

Gloss Black



Part No.	Height	Depth	Width	# Doors	Wt. (lb)	Cat.
1705795	18	18	18	1	26	530 (Y)
1705800	18	18	24	1	32	530 (Y)
1705803	18	18	30	2	42	530 (Y)
1705805	18	18	36	2	49	530 (Y)
1705810	18	18	48	2	63	530 (Y)
1705815	18	18	60	2	77	530 (Y)
1705825	24	24	24	1	43	530 (Y)
1705833	24	24	30	2	69	530 (Y)
1705835	24	24	36	2	75	530 (Y)
1705840	24	24	48	2	87	530 (Y)
1705845	24	24	60	2	99	530 (Y)
1705850	24	24	72	2	98	530 (Y)

Aluminum Underbody

Diamond Tread Aluminum



Part No.	Height	Depth	Width	# Doors	Wt. (lb)	Cat.
1705201	18	18	18	1	27	530 (Y)
1705200	18	18	24	1	36	530 (Y)
1705203	18	18	30	1	42	530 (Y)
1702230	24	24	30	1	52	530 (Y)
1705205	18	18	36	2	49	530 (Y)
1705210	18	18	48	2	63	530 (Y)
1705215	18	18	60	2	77	530 (Y)
1702225	24	24	24	1	45	530 (Y)
1702235	24	24	36	2	71	530 (Y)
1702240	24	24	48	2	76	530 (Y)
1702250	24	24	60	2	87	530 (Y)



See pg. 34-35 for Underbody Mounting Brackets

Aluminum Underbody

COMPRESSION LATCH

- .100" thick diamond tread aluminum
- Drop-down recessed door
- Locking die-cast T-handle compression latch
- Aluminum bolt-on continuous hidden hinge
- Replaceable gasket sealing system
- Aircraft grade door cables
- Reinforced door backbone on boxes 48" and wider
- Door opening: flat surface mount (90°) or underbody mount (180°)



Diamond Tread, Single Latch



Part No.	Height	Depth	Width	# Latches per Door	Wt. (lb)	Cat.
1705148	14	12	16	1	18	530 (Y)
1705149	14	12	18	1	19	530 (Y)
1705150	14	12	24	1	23	530 (Y)
1705153	14	12	30	1	26	530 (Y)
1705160	14	16	24	1	25	530 (Y)
1705102	18	18	14	1	25	530 (Y)
1705101	18	18	18	1	30	530 (Y)
1705100	18	18	24	1	33	530 (Y)
1705103	18	18	30	1	39	530 (Y)
1705105	18	18	36	1	43	530 (Y)
1705118	20	20	36	1	46	530 (Y)
1705119	18	24	36	1	56	530 (Y)
1705130	24	24	24	1	45	530 (Y)
1705133	24	24	30	1	52	530 (Y)
1705135	24	24	36	1	60	530 (Y)

Diamond Tread, Dual Latch



Part No.	Height	Depth	Width	# Latches per Door	Wt. (lb)	Cat.
1705110	18	18	48	2	57	530 (Y)
1705115	18	18	60	2	66	530 (Y)
1705113*	18	18	72	2	76	530 (Y)
1705120	18	24	48	2	64	530 (Y)
1705125	18	24	60	2	82	530 (Y)
1705127*	18	24	72	2	82	530 (Y)
1705140	24	24	48	2	75	530 (Y)
1705145	24	24	60	2	89	530 (Y)
1705147	24	24	72	2	97	530 (Y)

COMPRESSION LATCH WITH SLANTED BACK

- Angled top allows room for fuel fill hoses on single rear wheel flat beds
- Locking die-cast T-handle compression latch
- Door opening: flat surface mount (90°) or underbody mount (180°)
- Drop-down recessed door
- Replaceable gasket sealing system

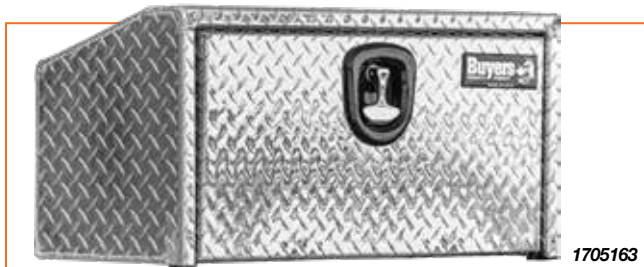

Part No.	Height	Depth	Width	# Latches per Door	Wt. (lb)	Cat.
1705163*	14	12	18	1	18	530 (Y)
1705166*	14	12	24	1	21	530 (Y)
1705169*	14	12	30	1	23	530 (Y)

* **NEW** PRODUCTS

Gloss Black Diamond Tread, Single Latch



Part No.	Height	Depth	Width	# Latches per Door	Wt. (lb)	Cat.
1725148	14	12	16	1	18	530 (Y)
1725149	14	12	18	1	23	503 (Y)
1725150	14	12	24	1	25	530 (Y)
1725153	14	12	30	1	27	530 (Y)
1725160	14	16	24	1	26	530 (Y)
1725101	18	18	18	1	27	530 (Y)
1725100	18	18	24	1	30	530 (Y)
1725103	18	18	30	1	38	530 (Y)
1725105	18	18	36	1	42	530 (Y)
1725116	18	24	30	1	40	530 (Y)
1725119	18	24	36	1	56	530 (Y)
1725125	18	24	60	1	64	530 (Y)
1725118	20	20	36	1	64	530 (Y)
1725130	24	24	24	1	46	530 (Y)
1725133	24	24	30	1	53	530 (Y)
1725135	24	24	36	1	59	530 (Y)

Gloss Black Diamond Tread, Dual Latch



Part No.	Height	Depth	Width	# Latches per Door	Wt. (lb)	Cat.
1725110	18	18	48	2	52	530 (Y)
1725115	18	18	60	2	70	530 (Y)
1725120	18	24	48	2	64	530 (Y)
1725140	24	24	48	2	76	530 (Y)
1725145	24	24	60	2	89	530 (Y)
1725147	24	24	72	2	97	530 (Y)

Textured Matte Black Diamond Tread, Single Latch



Part No.	Height	Depth	Width	# Latches per Door	Wt. (lb)	Cat.
1715105	18	18	36	1	42	530 (Y)

Textured Matte Black Diamond Tread, Dual Latch



Part No.	Height	Depth	Width	# Latches per Door	Wt. (lb)	Cat.
1715110	18	18	48	2	52	530 (Y)
1715115	18	18	60	2	70	530 (Y)

Aluminum Underbody

3-POINT COMPRESSION LATCH

- .100" thick diamond tread aluminum
- Drop-down recessed door
- Die-cast T-handle compression latch with 3-point locking system
- Aluminum bolt-on continuous hidden hinge
- Replaceable gasket sealing system
- Aircraft grade door cables
- Reinforced door backbone
- Door opening: flat surface mount (90°) or underbody mount (180°)



Diamond Tread



Part No.	Height	Depth	Width	# Latches per Door	Wt. (lb)	Cat.
1735101*	18	18	18	1	27	530 (Y)
1735100	18	18	24	1	33	530 (Y)
1735103	18	18	30	1	38	530 (Y)
1735105	18	18	36	1	44	530 (Y)
1735110*	18	18	48	1	54	530 (Y)
1735115*	18	18	60	1	63	530 (Y)
1735116*	18	24	30	1	44	530 (Y)
1735119*	18	24	36	1	51	530 (Y)
1735120*	18	24	48	1	63	530 (Y)
1735125*	18	24	60	1	76	530 (Y)
1735130	24	24	24	1	45	530 (Y)
1735133	24	24	30	1	58	530 (Y)
1735135	24	24	36	1	63	530 (Y)
1735140*	24	24	48	1	72	530 (Y)
1735145*	24	24	60	1	87	530 (Y)

ALUMINUM UNDERBODY WITH DRAWERS

- .100" thick diamond tread aluminum
- Drawer comes with adjustable dividers and 100 lb rated 16" slides
- Drop-down recessed door
- Locking die-cast T-handle compression latch
- Continuous hidden hinge
- Replaceable gasket sealing system
- Door opening: flat surface mount (90°) or underbody mount (180°)
- Reinforced door backbone
- Aircraft grade door cables



Part No.	Height	Depth	Width	# Latches per Door	Wt. (lb)	Cat.
1712200	20	18	24	1	50	530 (Y)
1712205	20	18	36	1	66	530 (Y)
1712210	20	18	48	1	85	530 (Y)

*** NEW PRODUCTS**

3-POINT T-HANDLE LATCH

Black, Single Latch

- Constructed of high-density polyethylene
- Drop down door
- Locking stainless steel 3-point T-handle latch
- Stainless steel hinge pin
- Replaceable gasket sealing system
- Aircraft grade door cables
- Molded double-wall door design



Part No.	Height	Depth	Width	# Latches per Door	Wt. (lb)	Cat.
1717100	18	18	24	1	24	530 (Y)
1717105	18	18	36	1	31	530 (Y)
1717110	18	18	48	1	42	530 (Y)



See pg. 34-35 for Underbody Mounting Brackets

Underbody Mounting Brackets

STEEL

- Sold in boxed pairs
- Universal hole pattern for quick and easy mounting
- Available with welded braces or bolt-on braces
- Available in heavy-duty structural steel (optional)
- Constructed of formed (optional) 3" wide steel C-channel, black powder-coated for corrosion resistance
- Hardware not included

Formed, Welded



Part No.	Description	Height	Depth	Wt. (lb)	Cat.
1701006	Formed Welded Brackets	18	18	16	531 (Y)
1701011	Formed Welded Brackets	18	24	19	531 (Y)
1701016	Formed Welded Brackets	24	24	22	531 (Y)

Formed, Bolted

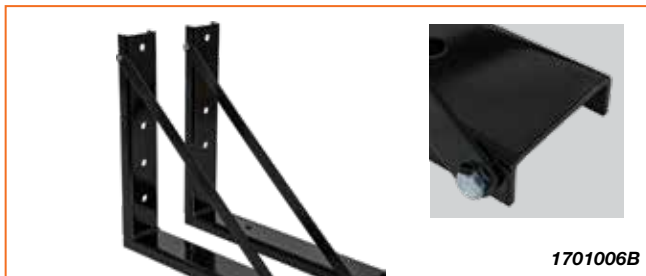

Part No.	Description	Height	Depth	Wt. (lb)	Cat.
1701006B	Formed Bolted Brackets	18	18	16	531 (Y)
1701011B	Formed Bolted Brackets	18	24	19	531 (Y)

Heavy Duty, Structural Welded



Part No.	Description	Height	Depth	Wt. (lb)	Cat.
1701005	Structural Welded Brackets	18	18	24	531 (Y)
1701010	Structural Welded Brackets	18	24	27	531 (Y)
1701015	Structural Welded Brackets	24	24	32	531 (Y)
1701012	Structural Welded Brackets	27	18	47	531 (Y)

Heavy Duty, Structural Bolted



Part No.	Description	Height	Depth	Wt. (lb)	Cat.
1701005B	Structural Bolted Brackets	18	18	24	531 (Y)
1701010B	Structural Bolted Brackets	18	24	27	531 (Y)

Underbody Mounting Brackets

STAINLESS STEEL

- Sold in boxed pairs
- Universal hole pattern for quick and easy mounting
- Welded braces
- 3/16" thick 304 stainless steel construction
- Hardware not included

Formed, Welded



1701031

Part No.	Description	Height	Depth	Wt. (lb)	Cat.
1701031	Welded Brackets	18	18	19	531 (Y)
1701041	Welded Brackets	18	24	22	531 (Y)

ALUMINUM

- Sold in boxed pairs
- Welded braces
- Aluminum construction
- 1/4" formed aluminum angles

Formed, Welded

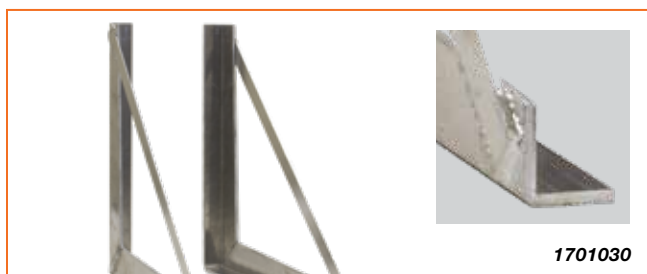

1701030

Part No.	Description	Height	Depth	Wt. (lb)	Cat.
1701030	Welded Brackets	18	18	7.5	531 (Y)
1701040	Welded Brackets	24	24	10	531 (Y)

FOR POLYMER UNDERBODIES

- Sold in boxed pairs
- Constructed of 3/16" thick 2" wide C-channel A-36 steel
- Black powder-coated
- Channel fits inside toolbox ribs
- Pre-drilled 7/16" mounting holes (nuts/bolts not included)

Formed, Welded



1701000

Part No.	Description	Height	Depth	Wt. (lb)	Cat.
1701000	Brackets for 24" and 36" Poly	15	14	14.3	530 (Y)
1701001	Brackets for 48" Poly	15	14	22.3	530 (Y)



TO



TOPSIDER

Topsiders



PRO SERIES STEEL TOPSIDERS

Gloss Black, Double Door

* See page 6-7 for details



Part No.	Height	Depth	Width	# Latches per Door	Wt. (lb)	Cat.
1752815†	18	18	60	1	175	530 (Y)
1752825†	18	18	72	1	202	530 (Y)
1752835†	18	18	90	1	228	530 (Y)
1752836†	18	18	96	1	250	530 (Y)
1754809	24	24	60	1	160	530 (Y)
1754811	24	24	72	1	175	530 (Y)
1754814	24	24	90	1	190	530 (Y)
1754817	24	24	96	1	210	530 (Y)

†Boxes can be used as topsiders and underbodies

T-HANDLE LATCH

- 16 gauge steel box with 14 gauge steel doors
- Drop-down recessed doors
- Locking stainless steel T-handle latches
- Bolt-on continuous hidden hinge
- Replaceable gasket sealing system
- Aircraft grade door cables
- Optional quick-mount trays
- Includes J-hooks for drill-free mounting and protective side rail pads
- Door opening: flat surface mount (90°)



Gloss Black



Part No.	Height	Depth	Width	# Latches per Door	Wt. (lb)	Cat.
1702940	16	13	72	1	115	530 (Y)
1702950	16	13	88	1	120	530 (Y)
1702960	16	13	96	2	128	530 (Y)
1702980	18	16	72	1	118	530 (Y)
1702990	18	16	88	1	136	530 (Y)
1703000	18	16	90	1	150	530 (Y)
1703020	18	16	96	2	151	530 (Y)

Optional Trays

Part No.	Height	Depth	Width	Wt. (lb)	Cat.
1702940TRAY	2.25/4	10.75	35	11	530 (Y)
1702950TRAY	2.25/4	10.75	43	14	530 (Y)
1702960TRAY	2.25/4	10.75	47	15	530 (Y)
1702980TRAY	2.25/4	13.75	35	12	530 (Y)
1702990TRAY	2.25/4	13.75	43	14	530 (Y)
1703000TRAY	2.25/4	13.75	44	15	530 (Y)
1703020TRAY	2.25/4	13.75	77	16	530 (Y)

Gloss White



Part No.	Height	Depth	Width	# Latches per Door	Wt. (lb)	Cat.
1702840	16	13	72	1	115	530 (Y)
1702850	16	13	88	1	120	530 (Y)
1702860	16	13	96	2	128	530 (Y)
1702880	18	16	72	1	118	530 (Y)
1702890	18	16	88	1	136	530 (Y)
1702895	18	16	90	1	136	530 (Y)
1702920	18	16	96	2	147	530 (Y)

Optional Trays

Part No.	Height	Depth	Width	Wt. (lb)	Cat.
1702840TRAY	2.25/4	10.75	35	11	530 (Y)
1702850TRAY	2.25/4	10.75	43	14	530 (Y)
1702860TRAY	2.25/4	10.75	47	15	530 (Y)
1702880TRAY	2.25/4	13.75	35	12	530 (Y)
1702890TRAY	2.25/4	13.75	43	14	530 (Y)
1702895TRAY	2.25/4	13.75	44	15	530 (Y)
1702920TRAY	2.25/4	13.75	77	16	530 (Y)

Aluminum Toppersider

FLIP UP DOOR WITH COMPRESSION LATCH

- Gas shocks hold door open at 110°
- .100" thick diamond tread aluminum
- Locking die-cast T-handle compression latch
- Full length stainless steel bolt-on continuous hidden hinge
- Built-in rain gutter with automotive bulb seal
- Reinforced door backbone
- Replaceable gasket sealing system



Diamond Tread, Single Latch

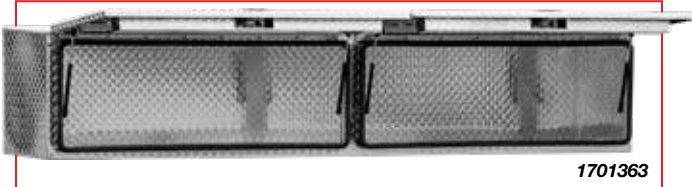

Part No.	Height	Depth	Width	# Latches per Door	Wt. (lb)	Cat.
1701351	16	13	72	1	78	530 (Y)
1701356	16	13	88	1	89	530 (Y)
1701363	18	16	72	1	82	530 (Y)
1701364	18	16	88	1	92	530 (Y)
1701365	18	16	90	1	99	530 (Y)

Diamond Tread, Dual Latch

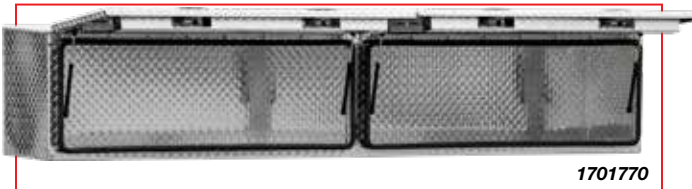

Part No.	Height	Depth	Width	# Latches per Door	Wt. (lb)	Cat.
1701361	16	13	96	2	92	530 (Y)
1701770	18	16	96	2	94	530 (Y)

Gloss Black Diamond Tread, Single Latch



Part No.	Height	Depth	Width	# Latches per Door	Wt. (lb)	Cat.
1721351	16	13	72	1	78	530 (Y)
1721356	16	13	88	1	89	530 (Y)
1721363	18	16	72	1	82	530 (Y)
1721364	18	16	88	1	92	530 (Y)
1721365	18	16	90	1	99	530 (Y)

Gloss Black Diamond Tread, Dual Latch



Part No.	Height	Depth	Width	# Latches per Door	Wt. (lb)	Cat.
1721361	16	13	96	2	92	530 (Y)
1721770	18	16	96	2	94	530 (Y)

Textured Matte Black Diamond Tread, Single Latch



Part No.	Height	Depth	Width	# Latches per Door	Wt. (lb)	Cat.
1722351	16	13	72	1	78	530 (Y)
1722356	16	13	88	1	89	530 (Y)
1722363	18	16	72	1	82	530 (Y)
1722364	18	16	88	1	92	530 (Y)
1722365	18	16	90	1	99	530 (Y)

Textured Matte Black Diamond Tread, Dual Latch



Part No.	Height	Depth	Width	# Latches per Door	Wt. (lb)	Cat.
1722361	16	13	96	2	92	530 (Y)
1722770	18	16	96	2	94	530 (Y)

DROP DOOR WITH COMPRESSION LATCH

- .100" thick diamond tread aluminum
- Locking die-cast T-handle compression latch
- Full length stainless steel bolt-on continuous hidden hinge
- Replaceable gasket sealing system
- Aircraft grade door cables
- Includes J-hooks for drill-free mounting and protective side rail pads
- Door opening: flat surface mount (90°)



Diamond Tread, Single Latch



Part No.	Height	Depth	Width	# Latches per Door	Wt. (lb)	Cat.
1701551	16	13	72	1	78	530 (Y)
1701556	16	13	88	1	89	530 (Y)
1701563	18	16	72	1	82	530 (Y)
1701564	18	16	88	1	92	530 (Y)
1701565	18	16	90	1	99	530 (Y)

Diamond Tread, Dual Latch



Part No.	Height	Depth	Width	# Latches per Door	Wt. (lb)	Cat.
1701561	16	13	96	2	92	530 (Y)
1701568	18	16	96	2	103	530 (Y)

Gloss Black Diamond Tread, Single Latch



Part No.	Height	Depth	Width	# Latches per Door	Wt. (lb)	Cat.
1721551	16	13	72	1	78	530 (Y)
1721556	16	13	88	1	89	530 (Y)
1721563	18	16	72	1	82	530 (Y)
1721564	18	16	88	1	92	530 (Y)
1721565	18	16	90	1	99	530 (Y)

Gloss Black Diamond Tread, Dual Latch



Part No.	Height	Depth	Width	# Latches per Door	Wt. (lb)	Cat.
1721561	16	13	96	2	92	530 (Y)
1721568	18	16	96	2	103	530 (Y)

Textured Matte Black Diamond Tread, Single Latch



Part No.	Height	Depth	Width	# Latches per Door	Wt. (lb)	Cat.
1722551	16	13	72	1	78	530 (Y)
1722556	16	13	88	1	89	530 (Y)
1722563	18	16	72	1	82	530 (Y)
1722564	18	16	88	1	92	530 (Y)
1722565	18	16	90	1	90	530 (Y)

Textured Matte Black Diamond Tread, Dual Latch



Part No.	Height	Depth	Width	# Latches per Door	Wt. (lb)	Cat.
1722561	16	13	96	2	92	530 (Y)
1722568	18	16	96	2	103	530 (Y)

Aluminum Topsider

SMOOTH ALUMINUM DROP DOOR WITH COMPRESSION LATCH

- .100" thick smooth aluminum
- Locking die-cast T-handle compression latch
- Full length stainless steel bolt-on continuous hidden hinge
- Replaceable gasket sealing system
- Aircraft grade door cables
- Includes J-hooks for drill-free mounting and protective side rail pads
- Door opening: flat surface mount (90°)



Smooth Aluminum, Single Latch



Part No.	Height	Depth	Width	# Latches per Door	Wt. (lb)	Cat.
1751651	16	13	72	1	78	530 (Y)
1751656	16	13	88	1	89	530 (Y)
1751663	18	16	72	1	93	530 (Y)
1751664	18	16	88	1	96	530 (Y)
1751665	18	16	90	1	99	530 (Y)

Smooth Aluminum, Dual Latch



Part No.	Height	Depth	Width	# Latches per Door	Wt. (lb)	Cat.
1751661	16	13	96	2	92	530 (Y)
1751668	18	16	96	2	103	530 (Y)

Smooth Aluminum, Single Latch, Gloss Black



Part No.	Height	Depth	Width	# Latches per Door	Wt. (lb)	Cat.
1752151	16	13	72	1	78	530 (Y)
1752156	16	13	88	1	89	530 (Y)
1752163	18	16	72	1	93	530 (Y)
1752164	18	16	88	1	96	530 (Y)
1752165	18	16	90	1	99	530 (Y)

Smooth Aluminum, Dual Latch, Gloss Black



Part No.	Height	Depth	Width	# Latches per Door	Wt. (lb)	Cat.
1752161	16	13	96	2	92	530 (Y)
1752168	18	16	96	2	103	530 (Y)

Aluminum Topsider

Smooth Aluminum, Single Latch, Gloss White



Part No.	Height	Depth	Width	# Latches per Door	Wt. (lb)	Cat.
1753151	16	13	72	1	78	530 (Y)
1753163	18	16	72	1	93	530 (Y)
1753165	18	16	90	1	99	530 (Y)

Smooth Aluminum, Dual Latch, Gloss White



Part No.	Height	Depth	Width	# Latches per Door	Wt. (lb)	Cat.
1753161	16	13	96	2	92	530 (Y)
1753168	18	16	96	2	103	530 (Y)



Aluminum Topsider

PICK-UP CONTRACTOR WITH LOWER COMPARTMENT

- .056" thick diamond tread aluminum
- Gas shocks lift and open door at over 90 degree angle
- Comes with two doors: top flip-up door and bottom drop door
- Locking stainless steel T-handle latches
- Replaceable gasket sealing system
- Aircraft grade door cables
- Mounting hardware included



1705640 open

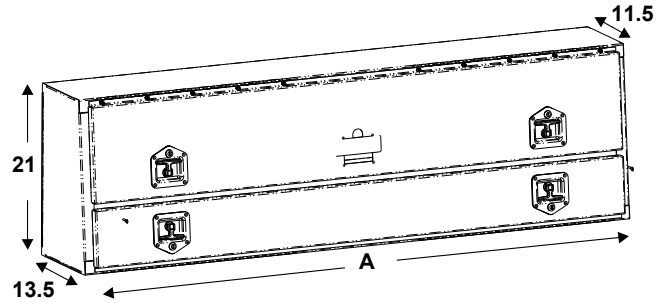

Diamond Tread



1705640

Part No.	Top Doors	Bottom Doors	Height	Depth	Width (A)	Wt. (lb)	Cat.
1705640	1	1	21	13.5/11.5	72	69	530 (Y)
1705650	1	1	21	13.5/11.5	88	84	530 (Y)
1705660	1	1	21	13.5/11.5	96	89	530 (Y)

Depth indicates bottom/top O.D.

Gloss Black Diamond Tread



1725640

Part No.	Top Doors	Bottom Doors	Height	Depth	Width (A)	Wt. (lb)	Cat.
1725640	1	1	21	13.5/11.5	72	69	530 (Y)
1725650	1	1	21	13.5/11.5	88	84	530 (Y)
1725660	1	1	21	13.5/11.5	96	89	530 (Y)

Depth indicates bottom/top O.D.

PICK-UP CONTRACTOR WITH TWO LOWER DRAWERS

- .056" thick diamond tread aluminum
- Gas shocks lift and open door at over 90 degree angle
- Locking stainless steel T-handle latches
- Replaceable gasket sealing system
- Bottom drawers come with adjustable dividers and 100 lb rated 12" slides
- Mounting legs and hardware included



1705641 open

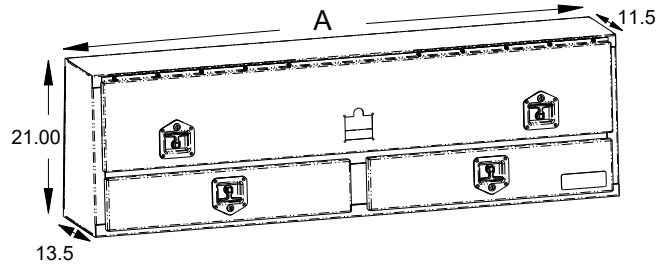

Diamond Tread



1705641

Part No.	Top Doors	Bottom Drawers	Height	Depth	Width (A)	Wt. (lb)	Cat.
1705641	1	2	21	13.5/11.5	72	58	530 (Y)
1705651	1	2	21	13.5/11.5	88	91	530 (Y)

Depth indicates bottom/top O.D.

Gloss Black Diamond Tread



1725651

Part No.	Top Doors	Bottom Drawers	Height	Depth	Width (A)	Wt. (lb)	Cat.
1725641	1	2	21	13.5/11.5	72	58	530 (Y)
1725651	1	2	21	13.5/11.5	88	91	530 (Y)

Depth indicates bottom/top O.D.

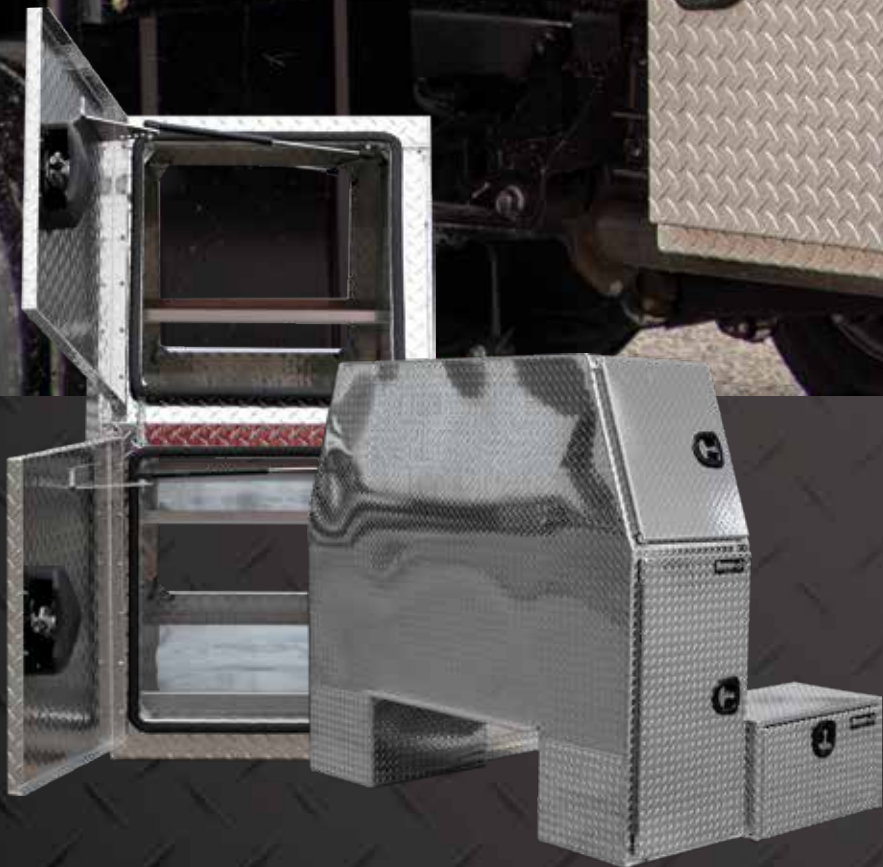

BAC

Choose a style ...

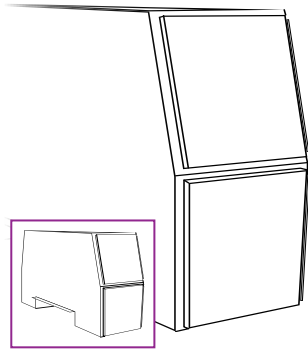

4 DOORS, SLANTED DOOR

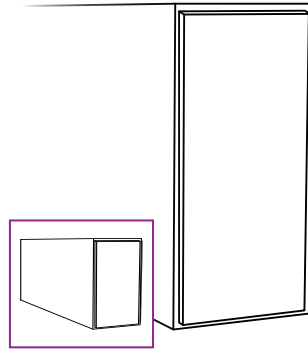

2 DOORS, STRAIGHT SIDES

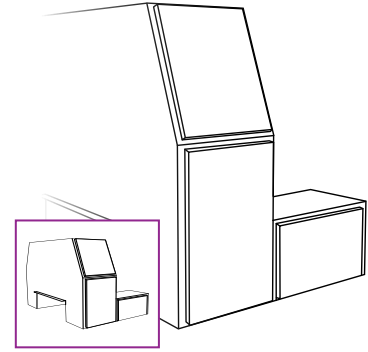

L-PACK

Choose a floor ...

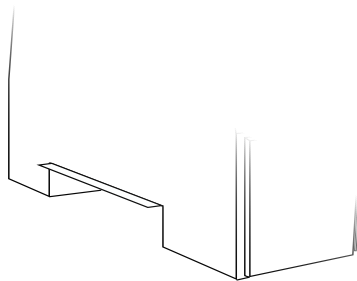

OFFSET FLOOR
(for conventional cabs)

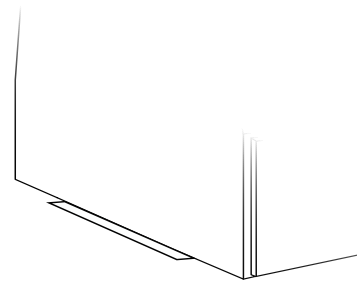

FLAT FLOOR
(for cab-over trucks)

Choose a material ...



DIAMOND TREAD
ALUMINUM



CARBON STEEL
GLOSS BLACK



CARBON STEEL
GLOSS WHITE

CKPACK

4 Doors, Offset Floor

DIAMOND TREAD ALUMINUM



- .100" thick aluminum diamond tread
- Universal spring cushion mounting kit, included with all aluminum backpack boxes, provides flex to reduce strain

Common Features



Manufactured by a talented workforce in Northeast Ohio

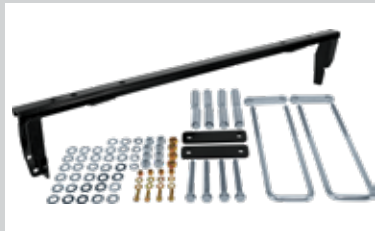

Backpack mounting adapter recommended for all 2017+ Ford® applications (see page 65 for details)



Stainless steel bolt-on continuous hidden hinges



Integral mounting rail for quick and easy installation



Doors open easily with gas powered shocks plus built-in rain gutter with automotive bulb seal



Two shelves to organize tools and equipment plus two folding driver side J-hooks

4 Doors, Offset Floor

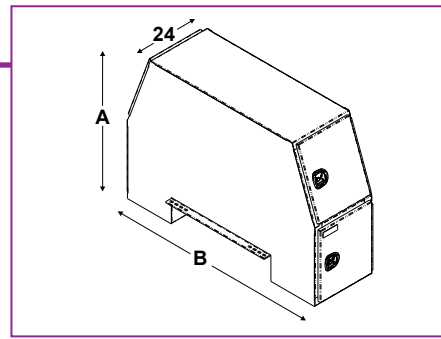

Diamond Tread Aluminum

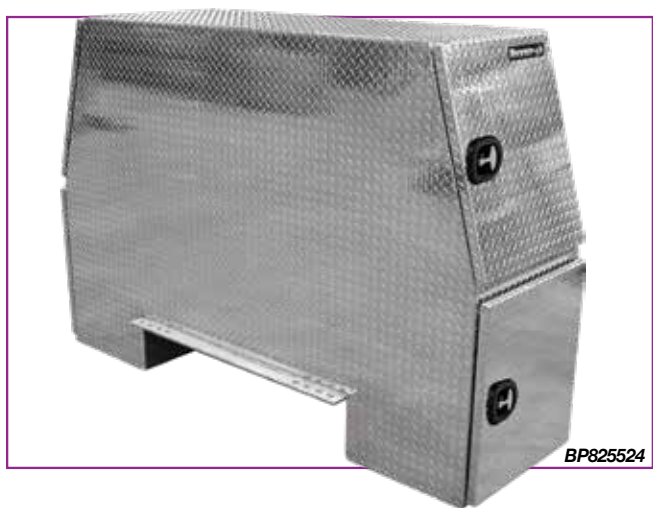

Part No.	Total Height (A)	Depth	Width (B)	Wt. (lb)	Cat.
BP825524	55	24	82	234	592 (Y)
BP826224	62	24	82	254	592 (Y)
BP826524	65	24	82	316	592 (Y)
BP827024	70	24	82	316	592 (Y)
BP925824	58	24	92	255	592 (Y)



****CAUTION:** Failure to use supplied mounting kit may void warranty on Aluminum Backpack Boxes

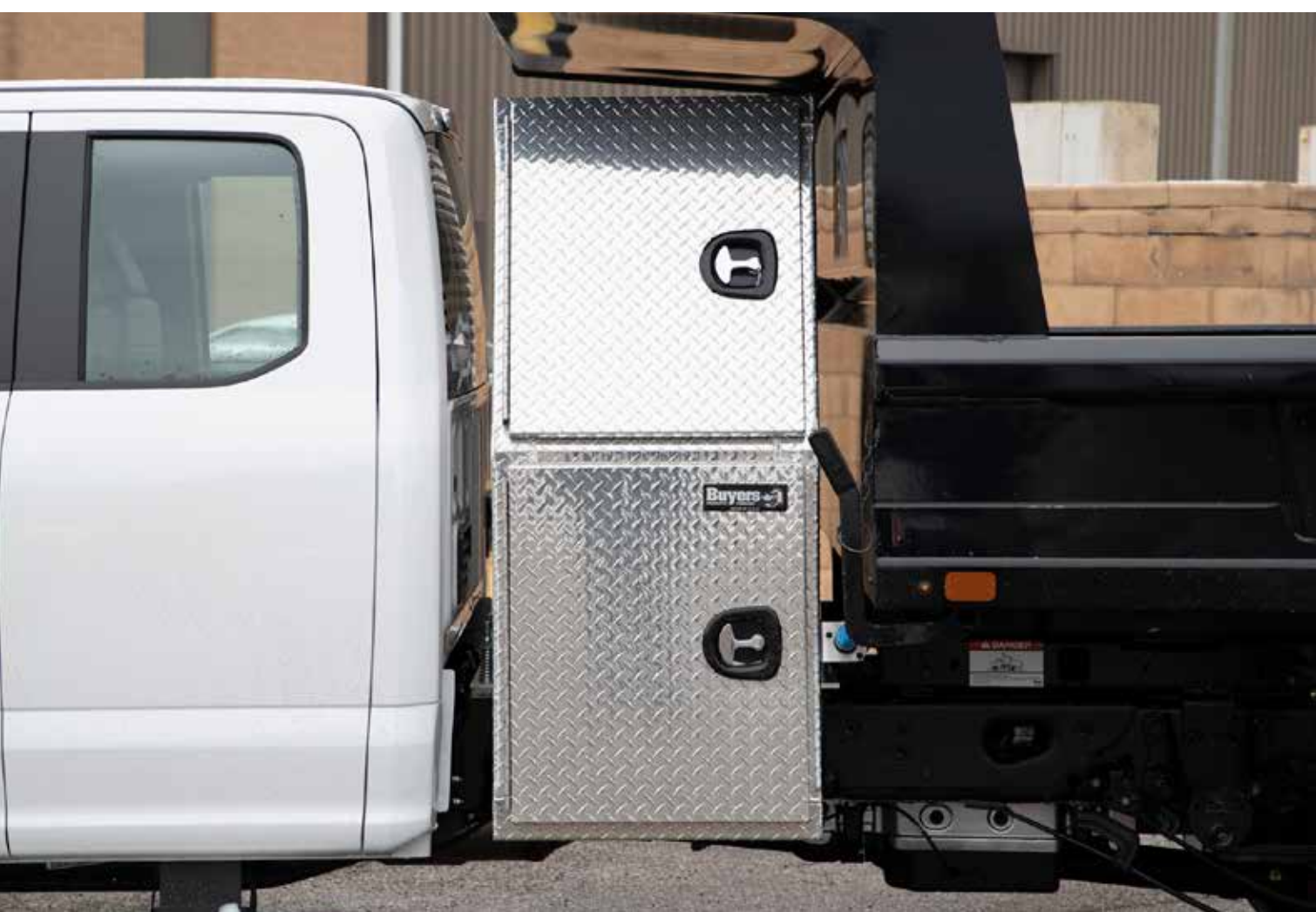

4 Doors, Offset Floor

CARBON STEEL



- 14 gauge steel box with 12 gauge steel doors
- Optional U-Bolt mounting kit sold separately (see page 64)

Common Features



Manufactured by a talented workforce in Northeast Ohio



Backpack mounting adapter recommended for all 2017+ Ford® applications (see page 65 for details)



Stainless steel bolt-on continuous hidden hinges



Integral mounting rail for quick and easy installation



Doors open easily with gas powered shocks plus built-in rain gutter with automotive bulb seal



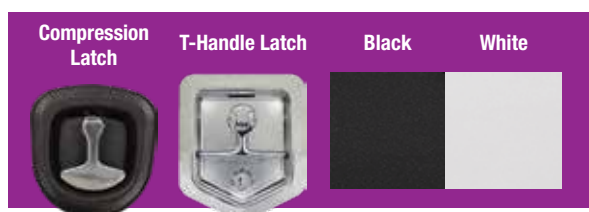
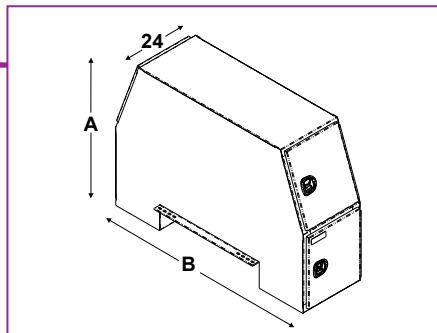

Two shelves to organize tools and equipment plus two folding driver side J-hooks

4 Doors, Offset Floor



Steel, Gloss Black Powder-Coated



Part No.	Total Height (A)	Depth	Width (B)	Wt. (lb)	Cat.
 BP855524B	55	24	85	536	592 (Y)
 BP826524B	65	24	82	600	592 (Y)
 BP925824B	58	24	92	576	592 (Y)

 For optional underbody box, see pages 62-63.

Steel, Gloss Black Powder-Coated Body, Polished Stainless Steel Doors





Part No.	Total Height (A)	Depth	Width (B)	Wt. (lb)	Cat.
 BP855524BSST	55	24	85	538	592 (Y)

 For optional underbody box, see pages 62-63.

Steel, Gloss White Powder-Coated



Part No.	Total Height (A)	Depth	Width (B)	Wt. (lb)	Cat.
 BP855524W	55	24	85	538	592 (Y)
 BP826524W	65	24	82	600	592 (Y)
 BP925824W	58	24	92	576	592 (Y)

 For optional underbody box, see pages 62-63.

4 Doors, Flat Floor

DIAMOND TREAD ALUMINUM



- .100" thick aluminum diamond tread
- Universal spring cushion mounting kit, included with all aluminum backpack boxes, provides flex to reduce strain

Common Features



Manufactured by a talented workforce in Northeast Ohio



Backpack mounting adapter recommended for all 2017+ Ford® applications (see page 65 for details)



Stainless steel bolt-on continuous hidden hinges

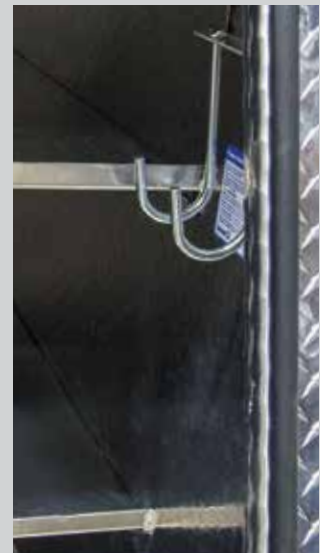

Two shelves to organize tools and equipment plus two folding driver side J-hooks



Integral mounting rail for quick and easy installation



Doors open easily with gas powered shocks plus built-in rain gutter with automotive bulb seal

4 Doors, Flat Floor

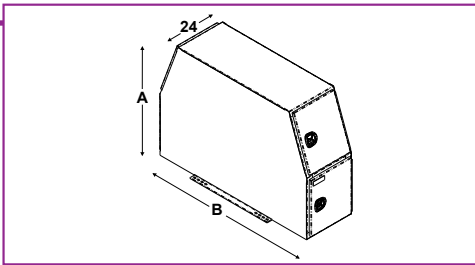

Compression Latch 	Diamond Tread 	Spring Cushion Mounting Kit** 
---	--	---

Diamond Tread Aluminum



Part No.	Total Height (A)	Depth	Width (B)	Wt. (lb)	Cat.
BP824624	46	24	82	216	592 (Y)
BP855924	59	24	85	350	530 (Y)

	For optional underbody box, see pages 62-63.
--	---

CAUTION: Failure to use supplied mounting kit may void warranty on Aluminum Backpack Boxes



4 Doors, Flat Floor

CARBON STEEL



- 14 gauge steel box with 12 gauge steel doors
- Optional U-Bolt mounting kit sold separately (see page 64)

Common Features



Manufactured by a talented workforce in Northeast Ohio

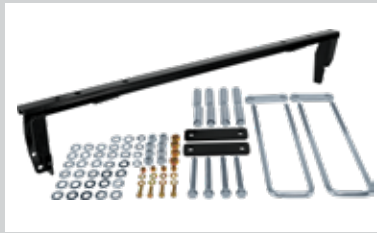

Backpack mounting adapter recommended for all 2017+ Ford® applications (see page 65 for details)



Stainless steel bolt-on continuous hidden hinges



Integral mounting rail for quick and easy installation



Doors open easily with gas powered shocks plus built-in rain gutter with automotive bulb seal



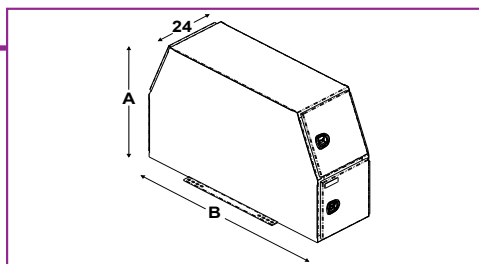

Two shelves to organize tools and equipment plus two folding driver side J-hooks

4 Doors, Flat Floor



Steel, Gloss Black Powder-Coated



Part No.	Total Height (A)	Depth	Width (B)	Wt. (lb)	Cat.
 BP824624B	46	24	82	454	592 (Y)
 BP855924B	59	24	85	536	592 (Y)

 For optional underbody box, see pages 62-63.

Steel, Gloss Black Powder-Coated Body, Polished Stainless Steel Doors





Part No.	Total Height (A)	Depth	Width (B)	Wt. (lb)	Cat.
 BP855924BSST	59	24	85	536	592 (Y)

 For optional underbody box, see pages 62-63.

Steel, Gloss White Powder-Coated



Part No.	Total Height (A)	Depth	Width (B)	Wt. (lb)	Cat.
 BP824624W	46	24	81	454	592 (Y)
 BP855924W	59	24	85	536	592 (Y)

 For optional underbody box, see pages 62-63.

2 Doors, Offset Floor

DIAMOND TREAD ALUMINUM



- .100" thick aluminum diamond tread
- Universal spring cushion mounting kit, included with all aluminum backpack boxes, provides flex to reduce strain

CARBON STEEL



- 14 gauge steel box with 12 gauge steel doors
- Optional U-Bolt mounting kit sold separately (see page 64)

Common Features



Manufactured by a talented workforce in Northeast Ohio



Backpack mounting adapter recommended for all 2017+ Ford® applications (see page 65 for details)



Stainless steel bolt-on continuous hidden hinges

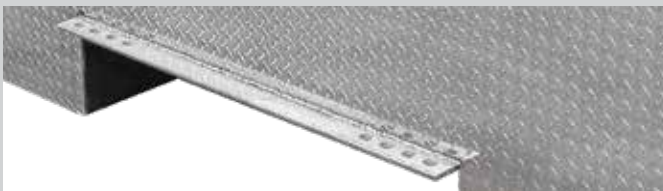

Integral mounting rail for quick and easy installation



Doors open easily with gas powered shocks plus built-in rain gutter with automotive bulb seal

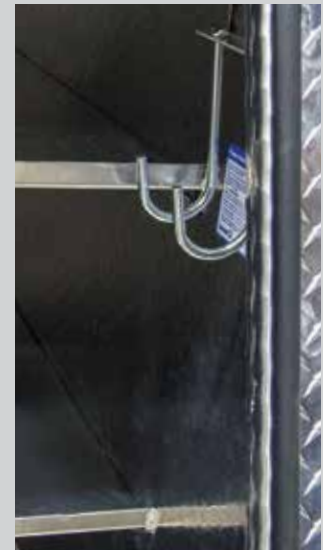

Two shelves to organize tools and equipment plus two folding driver side J-hooks

Diamond Tread Aluminum



Part No.	Total Height	Depth	Width	Wt. (lb)	Cat.
BP965724	57	24	96	262	592 (Y)



⚠️ CAUTION: Failure to use supplied mounting kit may void warranty on Aluminum Backpack Boxes

Steel, Gloss Black Powder-Coated



Part No.	Total Height	Depth	Width	Wt. (lb)	Cat.
BP965724B	57	24	96	690	592 (Y)



Steel, Gloss White Powder-Coated



Part No.	Total Height	Depth	Width	Wt. (lb)	Cat.
BP965724W	57	24	96	690	592 (Y)



2 Doors, Flat Floor

DIAMOND TREAD ALUMINUM



- .100" thick aluminum diamond tread
- Universal spring cushion mounting kit, included with all aluminum backpack boxes, provides flex to reduce strain

CARBON STEEL



- 14 gauge steel box with 12 gauge steel doors
- Optional U-Bolt mounting kit sold separately (see page 64)

Common Features



Manufactured by a talented workforce in Northeast Ohio

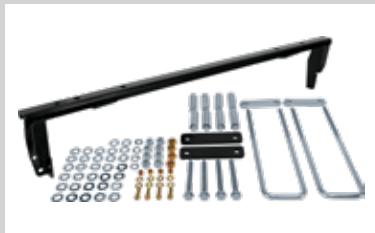

Backpack mounting adapter recommended for all 2017+ Ford® applications (see page 65 for details)



Stainless steel bolt-on continuous hidden hinges



Integral mounting rail for quick and easy installation



Doors open easily with gas powered shocks plus built-in rain gutter with automotive bulb seal



Two shelves to organize tools and equipment plus two folding driver side J-hooks

Diamond Tread Aluminum



BP964824

CAUTION: Failure to use supplied mounting kit may void warranty on Aluminum Backpack Boxes



Part No.	Total Height	Depth	Width	Wt. (lb)	Cat.
BP964824	48	24	96	240	592 (Y)



Steel, Gloss Black Powder-Coated



BP964824B



Part No.	Total Height	Depth	Width	Wt. (lb)	Cat.
BP964824B	48	24	96	700	592 (Y)
BP964824BLL	48	24	96	700	592 (Y)

BP964824BLL comes with 2 full length adjustable shelves



Steel, Gloss White Powder-Coated



BP964824W

Part No.	Total Height	Depth	Width	Wt. (lb)	Cat.
BP964824W	48	24	96	700	592 (Y)
BP964824WLL	48	24	96	700	592 (Y)

BP964824WLL comes with 2 full length adjustable shelves



Steel, Primed Powder-Coated



BP964824P

Part No.	Total Height	Depth	Width	Wt. (lb)	Cat.
BP964824P	48	24	96	700	592 (Y)



L-Pack

DIAMOND TREAD ALUMINUM

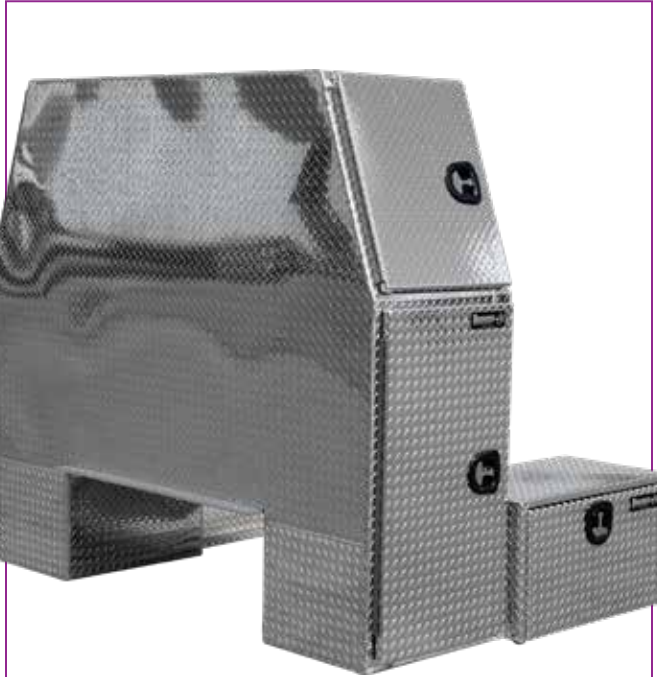

- .100" thick aluminum diamond tread
- Ships with 2 additional 30" underbody boxes welded on to provide additional storage
- Universal spring cushion mounting kit, included with all aluminum backpack boxes, provides flex to reduce strain

CARBON STEEL



- Tough 14 gauge steel body and 12 gauge steel doors with a corrosion resistant powder-coated finish
- Ships with 2 additional 24" underbody boxes bolted on to provide additional storage
- Optional U-Bolt mounting kit sold separately (see page 64)

Common Features



Manufactured by a talented workforce in Northeast Ohio

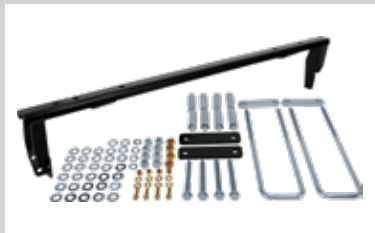

Backpack mounting adapter recommended for all 2017+ Ford® applications (see page 65 for details)



Stainless steel bolt-on continuous hidden hinges

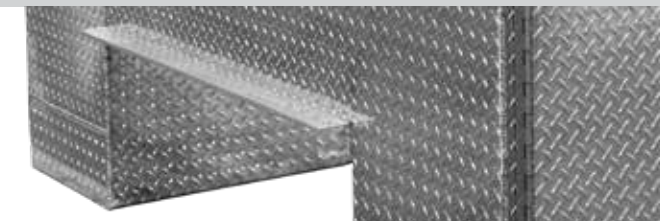

Integral mounting rail for quick and easy installation



Doors open easily with gas powered shocks plus built-in rain gutter with automotive bulb seal

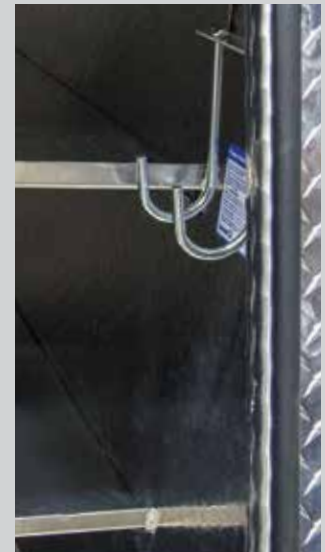

Two shelves to organize tools and equipment plus two folding driver side J-hooks

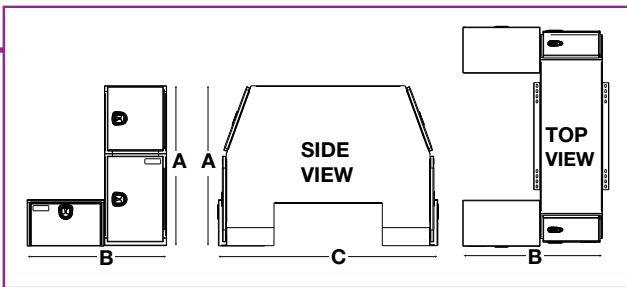

Diamond Tread Aluminum

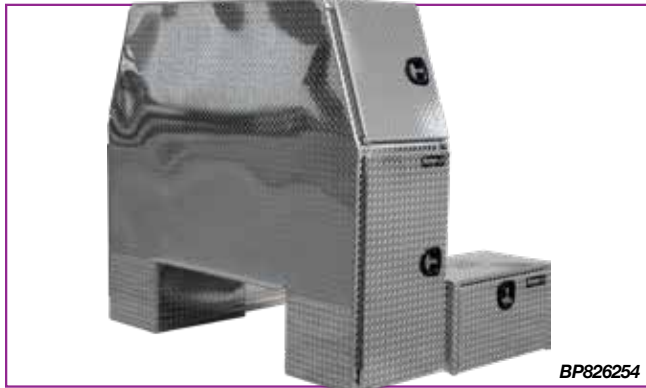

Part No.	Total Height (A)	Depth (C)	Width (B)	Wt. (lb)	Cat.
BP826254	62	54	82	340	592 (Y)
BP826554	65	54	82	314	592 (Y)
BP827054	70	54	82	384	592 (Y)

****CAUTION:** Failure to use supplied mounting kit may void warranty on Aluminum Backpack Boxes

Steel, Gloss Black Powder-Coated



Part No.	Total Height (A)	Depth (C)	Width (B)	Wt. (lb)	Cat.
BP855548B	55	54	82	638	592 (Y)

Steel, Gloss White Powder-Coated



Part No.	Total Height (A)	Depth (C)	Width (B)	Wt. (lb)	Cat.
BP855548W	55	54	82	638	592 (Y)

Underbody Boxes for Backpacks

DIAMOND TREAD ALUMINUM



- Can be used as bolt-on or weld-on underbodies with any backpack box
- Durable, corrosion-resistant, .100" thick aluminum diamond tread
- Locking die-cast T-handle compression latch

CARBON STEEL



- Can be used as bolt-on underbodies with any backpack box
- 14 gauge powder-coated steel box
- Locking stainless steel T-handle latch

Common Features



Manufactured by a talented workforce in Northeast Ohio



Drop-down recessed door



Aluminum bolt-on continuous hidden hinge and replaceable gasket sealing system

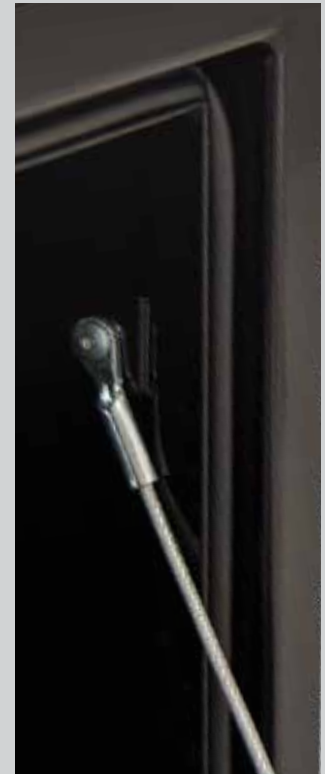

Aircraft grade door cables

Underbody Boxes for Backpacks

Diamond Tread Aluminum



Part No.	Height	Depth	Width	Wt. (lb)	Cat.
BP141624	14	16	24	18	530

Steel, Gloss Black Powder-Coated



Part No.	Height	Depth	Width	Wt. (lb)	Cat.
1703300	14	16	25	46	530
1703303	14	16	30	55	530
1703304*	14	16	30	72	530

*Includes built-in shelf

Steel, Gloss White Powder-Coated



Part No.	Height	Depth	Width	Wt. (lb)	Cat.
1703400	14	16	24	46	530

Steel, Primed Powder-Coated



Part No.	Height	Depth	Width	Wt. (lb)	Cat.
1703900	14	16	24	46	530

Accessories

STEEL AND ALUMINUM BACKPACK ACCESSORIES



Universal Spring Cushion Mounting Kit

- Provides flex to reduce strain on steel and aluminum backpack truck boxes
- Ideal for off-road applications
- 5/8" U-bolts with forged tie bars, springs and fasteners (all zinc plated)
- Included with all aluminum backpacks
- ⚠ **CAUTION:** Failure to use supplied mounting kit may void warranty on aluminum backpack boxes
- Additional sizes available as custom orders

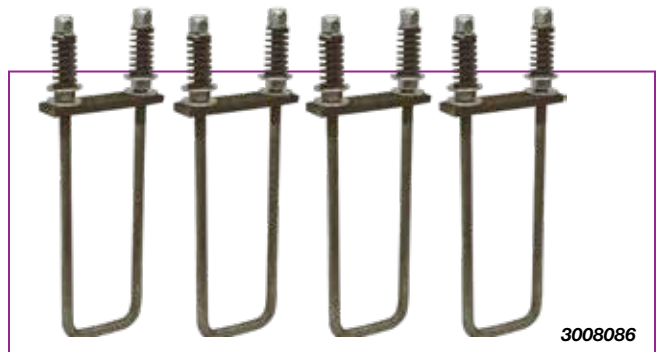

Part No.	Description	Wt. (lb)	Cat.
3008086	Universal Spring Cushion Mounting Kit	17	531 (Y)

Universal Square Bend U-Bolt Kit

- Secure truck boxes to truck body, or connect body to truck chassis
- 5/8" U-Bolts with fasteners and forged tie bars
- Durable Grade 5 hardware
- Additional sizes available as custom orders

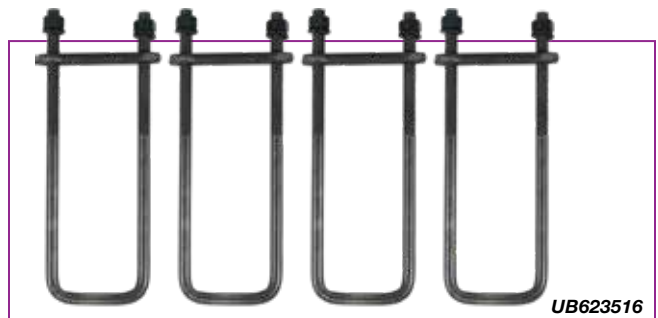

Part No.	Description	Wt. (lb)	Cat.
UB623516	Universal Mounting Kit	17	531 (Y)

Backpack Mounting Adapter

- Provides a level base with a pre-fabricated kit that ensures optimal fit and reduced installation time
- Black powder-coated bracket and zinc plated hardware add corrosion resistance
- Recommended for use with all Ford® 2017+ applications

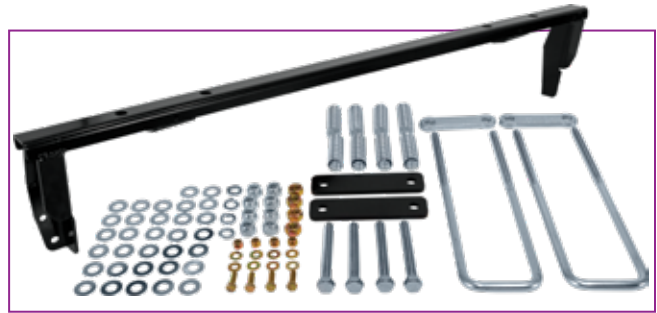

Part No.	Description	Wt. (lb)	Cat.
3037014	For Ford F350, F450, F550 (2017 - Mid 2020)	47.24	531 (Y)
3037014A	For Ford F350, F450, F550 (2020+)	46.96	531 (Y)

J-Hook Hanger

- Universal J-hook hangers for holding items like chains or straps
- Bolt-on or weld-on
- Folding zinc plated J-hooks swing flush with compartment walls when not in use
- Hanger 3009122 comes installed inside every box*

*Excludes BP964824BLL and BP964824WLL due to full-length shelving.

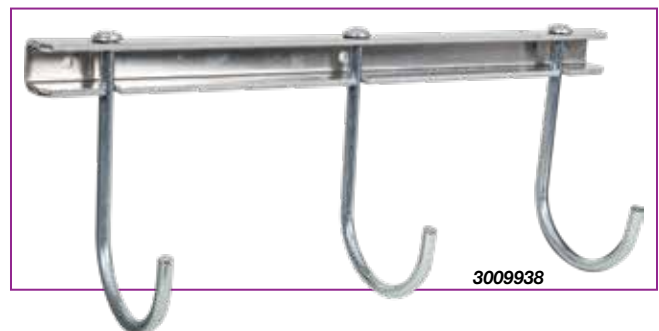

Part No.	Description	Wt. (lb)	Cat.
3009122	Double J-Hook with Steel Mounting Angle	0.85	530-1 (N)
3009938	Triple J-Hook with Aluminum Mounting Angle	2.16	530-1 (N)
3009123	Double J-Hook with Aluminum Mounting angle	0.51	530-1 (N)

Accessories

Silicone LED Strip Lights With 3M™ Adhesive Back

- Flexible strip lights can be mounted nearly anywhere extra light is needed. Ideal for tool boxes, truck beds, storage boxes, and trunk areas
- Each strip has a blunt cut connection on both ends and can be cut to length every three LEDs
- IP67 rated for water and dust resistance and backed with a 5 year warranty
- Includes end caps and mounting clips
- Separate 17.5" mounting channel also available



Connection	Blunt Cut, Both Ends
Hardware Included	End Caps and Mounting Clips

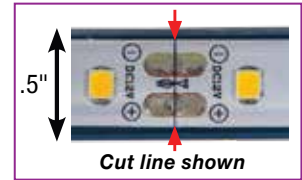

Clear Warm Strip Lights

Part No.	Size	LED's	Amps	Lumens	Wt. (lbs.)	Cat.
5622029	18"	27	0.45	486	0.31	562 (N)
5622840	24"	36	0.60	648	0.35	562 (N)
5623856	36"	54	0.90	972	0.40	562 (N)
5625276	48"	72	1.20	1,296	0.44	562 (N)



Clear Cool Strip Lights

Part No.	Size	LED's	Amps	Lumens	Wt. (lbs.)	Cat.
5622120	18"	27	0.45	513	0.31	562 (N)
5622941	24"	36	0.60	684	0.35	562 (N)
5623957	36"	54	0.90	1,026	0.40	562 (N)
5625377	48"	72	1.20	1,368	0.44	562 (N)



LED Strip Lights With 3M™ Adhesive Back



Connection	Blunt Cut, Both Ends
Hardware Included	End Caps and Mounting Clips

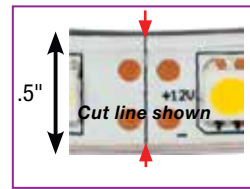

Clear Warm Strip Lights

Part No.	Size	LED's	Amps	Lumens	Wt. (lbs.)	Cat.
5621827	18"	27	0.41	360	0.31	562 (N)
5622436	24"	36	0.54	470	0.35	562 (N)
5623654	36"	54	0.81	710	0.40	562 (N)
5624872	48"	72	1.12	940	0.44	562 (N)
5626090	60"	90	1.30	1,180	0.55	562 (N)
56296144	96"	144	2.00	2,160	0.88	562 (N)



Clear Cool Strip Lights

Part No.	Size	LED's	Amps	Lumens	Wt. (lbs.)	Cat.
5621928	18"	27	0.41	360	0.31	562 (N)
5622537	24"	36	0.54	470	0.35	562 (N)
5623755	36"	54	0.81	710	0.40	562 (N)
5624973	48"	72	1.12	940	0.44	562 (N)
5626191	60"	90	1.30	1,175	0.55	562 (N)
56297145	96"	144	2.00	2,160	0.88	562 (N)
562109166	108"	165	3.00	2,400	1.12	562 (N)
562133202	132"	201	4.00	3,000	1.37	562 (N)



Accessories

Part No.	Description	Wt. (lbs.)	Cat.
3035896	LED Strip Light Mounting Channel, 17-1/2" Long, Black, Mounting 3M® Tape	0.39	562 (N)



Accessories

Part No.	Description	Wt. (lbs.)	Cat.
5621002	LED Strobe Controller with 6" Leads Converts Steady-On Strip Lights to a Strobe Pattern	0.07	562 (N)



TUNNEL



L BOXES

Tunnel Boxes

ALL NEW

DIAMOND TREAD ALUMINUM



- .100" thick aluminum diamond tread

CARBON STEEL



- 15 gauge steel box with 12 gauge steel doors

Common Features



Manufactured by a talented workforce in Northeast Ohio



1/4 in. stainless steel continuous hinges



Rain channel and watertight automotive bulb seal keeps tools protected



Full length stationary shelf provides organization for tools and equipment.

Diamond Tread Aluminum

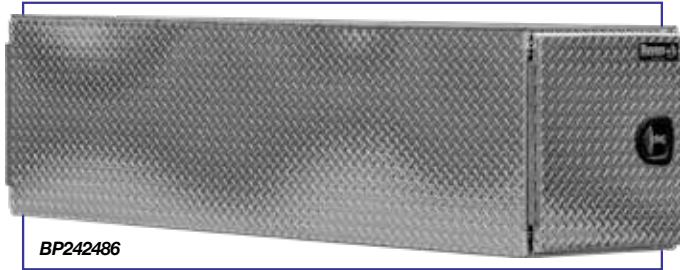

Part No.	Height	Depth	Width	Wt. (lb)	Cat.
BP242486*	24	24	86	125	592 (Y)
BP242496*	24	24	96	135	592 (Y)

Steel, Gloss Black Powder-Coated



Part No.	Height	Depth	Width	Wt. (lb)	Cat.
BP242486B*	24	24	86	245	592 (Y)
BP242496B*	24	24	96	265	592 (Y)

Steel, Gloss White Powder-Coated



Part No.	Height	Depth	Width	Wt. (lb)	Cat.
BP242486W*	24	24	86	245	592 (Y)
BP242496W*	24	24	96	265	592 (Y)



IN-BED S



STORAGE

Crossover Truck Boxes

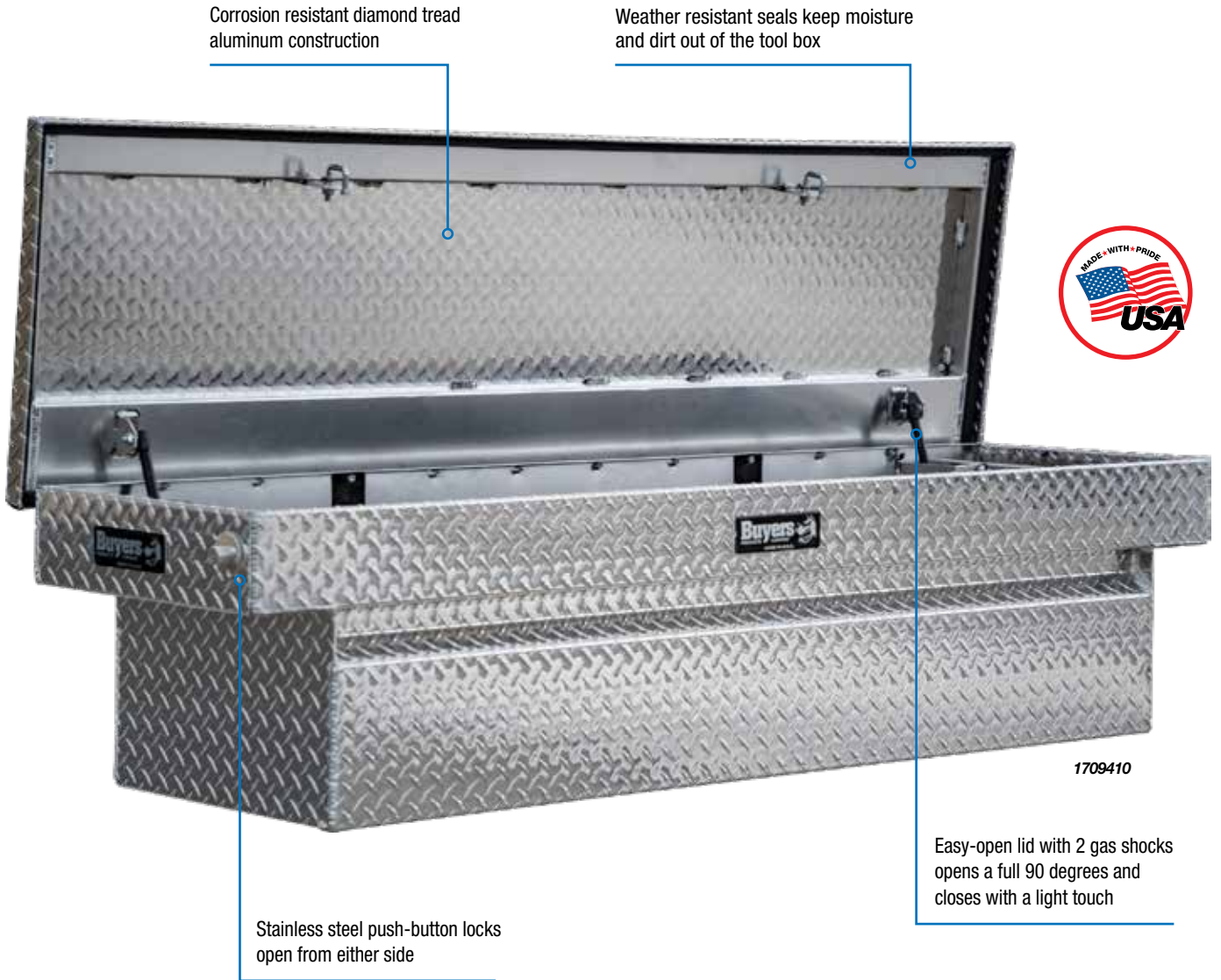

Corrosion resistant diamond tread aluminum construction

Weather resistant seals keep moisture and dirt out of the tool box



1709410

Stainless steel push-button locks open from either side

Easy-open lid with 2 gas shocks opens a full 90 degrees and closes with a light touch

Crossover Features



Lockable tray and integrated tool holders make it easy to stay organized



Stainless steel push-button locks



Fully concealed aluminum continuous hinge

SINGLE LID WITH PUSH-BUTTON LOCK

- Available for full-size and compact pickups
- Gas shock props lid open
- Stainless steel push-button locks open from either side
- Suspends from pickup side rails
- Includes standard mounting hardware
- Locking tool tray with removable dividers
- Pre-drilled mounting holes and included hardware make installation easy

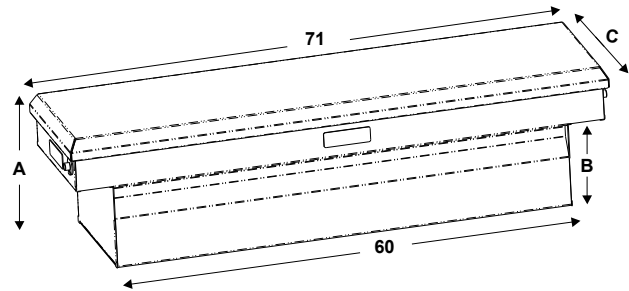
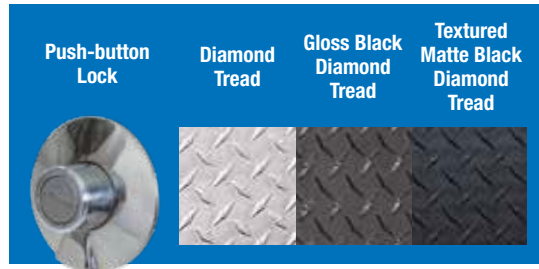

Diamond Tread



Part No.	Height (A/B)	Depth (C)	Width	Wt. (lb)	Cat.
1709410	18/11	20	71/60	75	530 (Y)
1709415	23/16	20	71/60	81	530 (Y)
1709420	18/11	27	71/60	89	530 (Y)
1709425	23/16	27	71/60	94	530 (Y)
1709430	13/6	20	63/54	63	530 (Y)



Optional Universal Mounting Kit, see page 90.

Gloss Black Diamond Tread



Part No.	Height (A/B)	Depth (C)	Width	Wt. (lb)	Cat.
1729410	18/11	20	71/60	75	530 (Y)
1729415	23/16	20	71/60	77	530 (Y)
1729420	18/11	27	71/60	89	530 (Y)
1729425	23/16	27	71/60	91	530 (Y)
1729430	13/6	20	63/54	63	530 (Y)



Optional Universal Mounting Kit, see page 90.

Textured Matte Black Diamond Tread



Part No.	Height (A/B)	Depth (C)	Width	Wt. (lb)	Cat.
1739410	18/11	20	71/60	75	530 (Y)
1739420	18/11	27	71/60	89	530 (Y)
1739415	23/16	20	71/60	81	530 (Y)
1739425	23/16	27	71/60	94	530 (Y)
1739430	13/6	20	63/54	63	530 (Y)



Optional Universal Mounting Kit, see page 90.

Gull Wing Truck Boxes

NEW DESIGN



Weather resistant seals keep moisture and dirt out of the tool box

Corrosion resistant diamond tread aluminum construction



Stainless steel push-button locks open from either side

Easy-open lids with 2 gas shocks opens and closes with a light touch

1710410

Gull Wing Features



Tools and equipment stay organized with included tray and dividers.



Stainless steel push-button locks



Fully concealed aluminum continuous hinge

GULL WING WITH PUSH-BUTTON LOCK

- Available for full-size pickups
- Gas shock props lid open
- Stainless steel push-button locks open from either side
- Suspends from pickup side rails
- Includes standard mounting hardware
- Locking tool tray with removable dividers
- Pre-drilled mounting holes and included hardware make installation easy

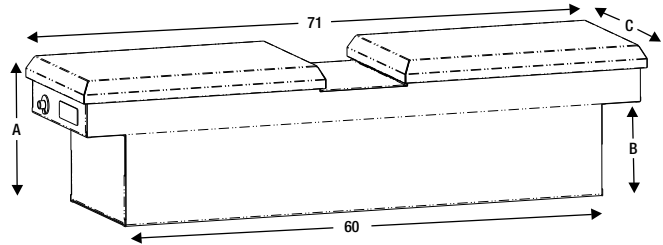

Diamond Tread



Part No.	Height (A/B)	Depth (C)	Width	Wt. (lb)	Cat.
1710410*	18/11	20	71/60	77	530 (Y)
1710413*	23/16	20	71/60	83	530 (Y)
1710420*	18/11	27	71/60	93	530 (Y)
1710423*	23/16	27	71/60	100	530 (Y)



Optional Universal Mounting Kit, see page 90.

Gloss Black Diamond Tread



Part No.	Height (A/B)	Depth (C)	Width	Wt. (lb)	Cat.
1720410*	18/11	20	71/60	77	530 (Y)
1720413*	23/16	20	71/60	83	530 (Y)
1720420*	18/11	27	71/60	93	530 (Y)
1720423*	23/16	27	71/60	100	530 (Y)



Optional Universal Mounting Kit, see page 90.

Textured Matte Black Diamond Tread

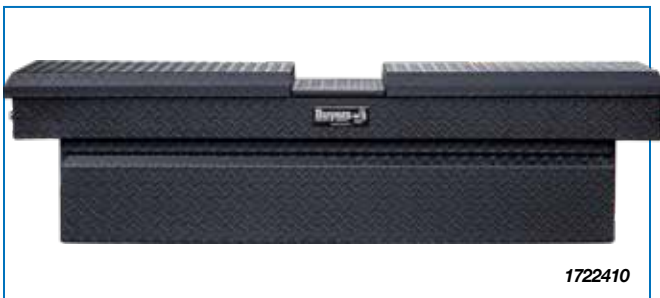

Part No.	Height (A/B)	Depth (C)	Width	Wt. (lb)	Cat.
1722410*	18/11	20	71/60	77	530 (Y)
1722413*	23/16	20	71/60	83	530 (Y)
1722420*	18/11	27	71/60	93	530 (Y)
1722423*	23/16	27	71/60	100	530 (Y)



Optional Universal Mounting Kit, see page 90.

Lo-Sider Truck Boxes

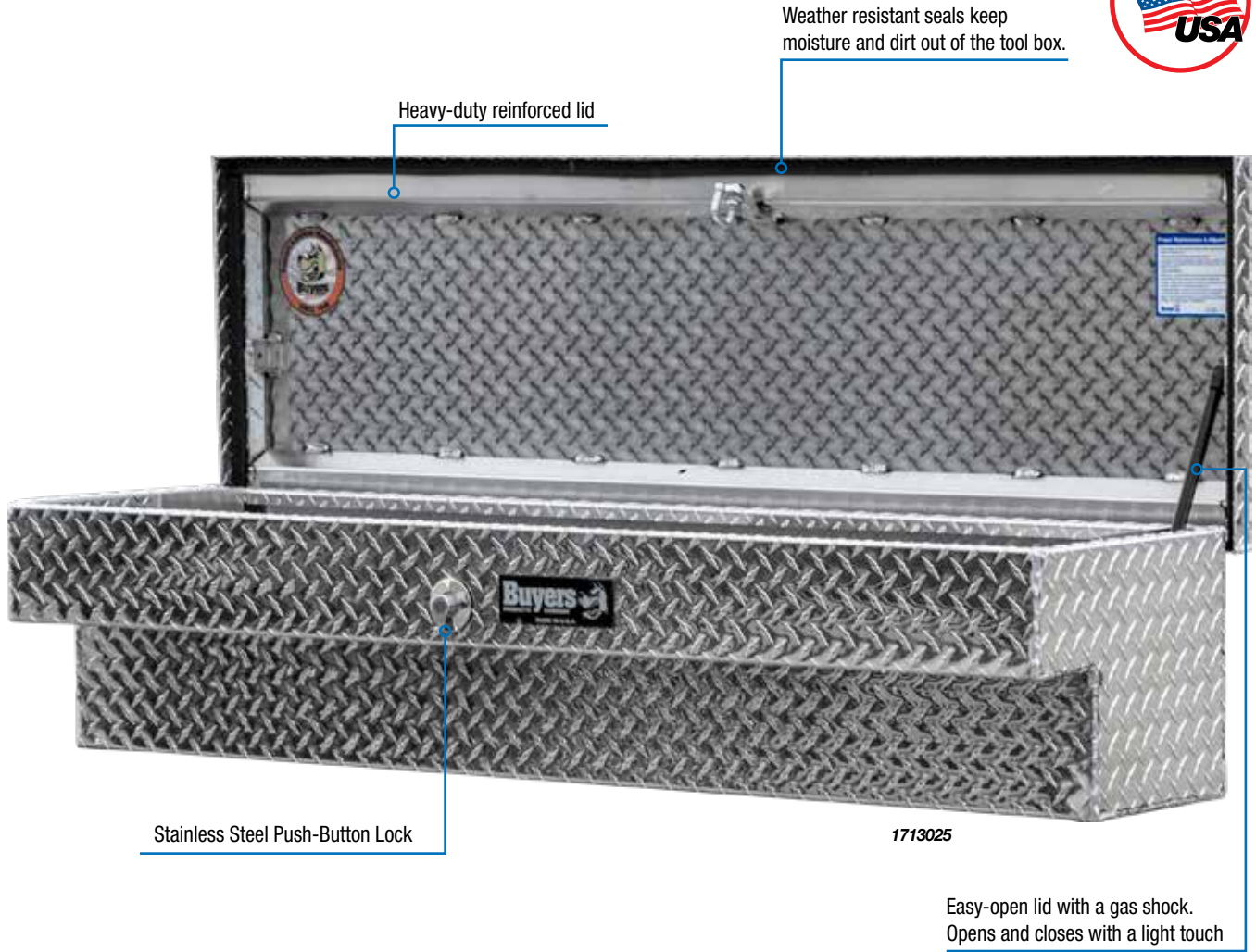

Heavy-duty reinforced lid

Weather resistant seals keep moisture and dirt out of the tool box.

Stainless Steel Push-Button Lock

1713025

Easy-open lid with a gas shock.
Opens and closes with a light touch

Lo-Sider/Rail Features



Corrosion resistant diamond tread aluminum construction is durable but lightweight.



Stainless steel push-button lock



Fully concealed aluminum Continuous hinge.

LO-SIDER WITH PUSH-BUTTON LOCK

- Available for full-size and compact pickups
- Gas shock props lid open
- Stainless steel push-button lock
- Suspends from pickup side rails
- Includes standard mounting hardware
- Pre-drilled mounting holes and included hardware make installation easy

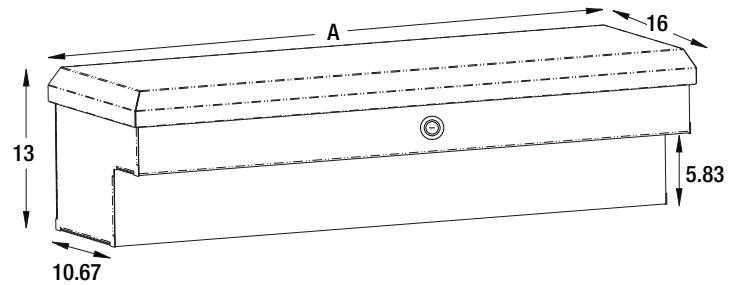

Diamond Tread



Part No.	Height	Depth	Width (A)	Wt. (lb)	Cat.
1713005*	13	16	36	26	530 (Y)
1713015*	13	16	47	30	530 (Y)
1713025*	13	16	56	34	530 (Y)
1713030*	13	16	70	40	530 (Y)
1713035*	13	16	87	46	530 (Y)

Gloss Black Diamond Tread



Part No.	Height	Depth	Width (A)	Wt. (lb)	Cat.
1723005*	13	16	36	26	530 (Y)
1723015*	13	16	47	30	530 (Y)
1723025*	13	16	56	34	530 (Y)
1723030*	13	16	70	40	530 (Y)
1723035*	13	16	87	46	530 (Y)

Textured Matte Black Diamond Tread



Part No.	Height	Depth	Width (A)	Wt. (lb)	Cat.
1733005*	13	16	36	26	530 (Y)
1733015*	13	16	47	30	530 (Y)
1733025*	13	16	56	34	530 (Y)
1733030*	13	16	70	40	530 (Y)
1733035*	13	16	87	46	530 (Y)

Storage Chests



Zinc-plated handles



Reinforced lid

Dual gas shocks
cover support

Stainless steel
push-button locks

Removable tray

Angled body design

1712030

Storage Chest Features



Gas shock cover support protects shocks from damage.



Two zinc-plated handles for easy lifting.



Reinforced lid for extra durability.



Angled body design is ideal for use with fifth wheel and goose-neck trailer applications.

ANGLED BASE WITH PUSH-BUTTON LOCK

- .056" thick diamond tread
- Stainless steel one-touch push-button locks
- Continuous aluminum hinge is welded to the lid and bolted to the box
- Offset lid allows for 90° opening when placed against truck bed
- Gas shock props lid open
- Includes tray and divider



Diamond Tread Aluminum



Part No.	Height	Depth	Width (A/B)	Cubic ft.	Wt. (lb)	Cat.
1712010†	18.5	20/15	47/47	10	53	530 (Y)
1712020†	18.5	20/15	55/54	12	55	530 (Y)
1712030††	19	20/16	60/52	12.5	60	530 (Y)
1712035††	19	27/27	60/52	18	74	530 (Y)

†Boxes have angled base on front only

††Boxes have angled base on front and sides

Textured Matte Black



Part No.	Height	Depth	Width (A/B)	Cubic ft.	Wt. (lb)	Cat.
1722010†	18.5	20/15	47/47	10	53	530 (Y)

†Boxes have angled base on front only

JUMBO CHEST WITH PADDLE LATCH

- .100" thick diamond tread
- Locking stainless steel paddle latch
- Continuous aluminum hinge is welded to the lid and bolted to the box
- Zinc plated handles



Diamond Tread Aluminum



Part No.	Height	Depth	Width	Cubic ft.	Wt. (lb)	Cat.
1712110	24	24/22	49	15	74	530 (Y)
1712120	30	30/28	49	24	92	530 (Y)

Storage Chests

POLY CHEST WITH 2" RECEIVER MOUNT

- Durable, lightweight high density polyethylene construction
- Fully enclosed, water resistant design
- Mounts in 2" hitch receivers to provide portable, accessible storage
- Great for camping, fishing, tailgating, and more
- 17 cubic feet of functional space
- Holds up to 300 pounds
- Double walled lid with two lockable hasps (padlocks sold separately)
- Steel frame with black powder-coated finish
- Comes pre-drilled for easy assembly and installation
- Comes with all hardware including 5/8in. hitch pin

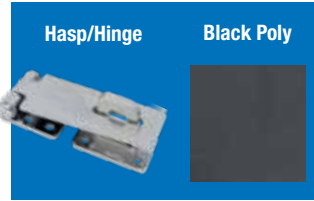

Part No.	# Hasps	Height	Depth	Width	Cubic ft.	Wt. (lb)	Cat.
1707020	2	26	23/21	51/47.25	17	76	530 (Y)



POLY CHEST WITH HASP

- Lightweight, dent-resistant, high-density polyethylene body
- Box contents stay safe and secure behind a molded, double-wall, stainless steel hinged lid
- Corrosion and weather resistant stainless steel hasp and hinge made for use with combination lock or padlock (lock sold separately)
- Mount to floor of pickup beds, trailers or for use in garages

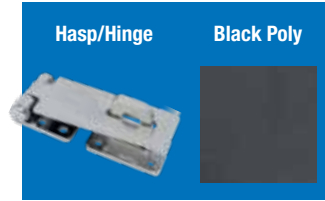

Black, Single Hasp



Part No.	# Hasps	Height	Depth	Width	Cubic ft.	Wt. (lb)	Cat.
1712230	1	13.5	15/9.25	32/29.5	2.6	16	530 (Y)
1712250	1	22.5	19.5/18.75	51/47	8.4	34	530 (Y)

Black, Dual Hasp



Part No.	# Hasps	Height	Depth	Width	Cubic ft.	Wt. (lb)	Cat.
1712240	2	17.25	19/13.25	44/41.25	6.3	28	530 (Y)
1712255	2	26	23/21	51/47.25	17	46	530 (Y)
1712260	2	23	25/19	77/73	18.8	52	530 (Y)

HEAVY DUTY POLY STORAGE BINS

- Constructed from durable and rust-proof polyethylene for years of use
- Double panel sloped lid provides a weather-resistant barrier to keep contents dry
- Molded hand holds and fork lift slots allow for easy lifting and carrying
- Ideal for storing dry, loose materials like rock salt, grain, sand, seed or litter
- Suitable for indoor or outdoor use

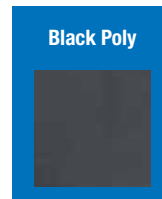

Part No.	Height	Depth	Width	Wt. (lb)	Cat.
9031105*	20	24	36	21	903-1 (N)
9031100	30	24	36	28	903-1 (N)

***SHIPS UPS!**

Material Scoop



Part No.	Height	Depth	Width	Wt. (lb)	Cat.
9031110	Material Scoop			2.47	903-1 (N)

Trailer Tongues

STEEL TRAILER TONGUE WITH PADDLE LATCH

- 15 gauge steel box and door
- Locking stainless steel paddle latch
- Stainless steel continuous hidden hinge
- Designed to mount to the front of A-frame style trailers

Gloss Black

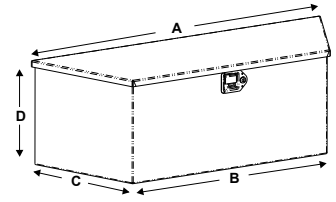

Part No.	Height (D)	Depth (C)	Width (A/B)	Wt. (lb)	Cat.
1701281	12.3	12.6	148./27.1	33	530 (Y)
1701280	16.3	14.3	21.2/35.1	51	530 (Y)
1701285	16.3	16.14	33.5/49	74	530 (Y)

ALUMINUM TRAILER TONGUE WITH PADDLE LATCH

- .056 thick diamond tread aluminum
- Locking stainless steel paddle latch
- Aluminum continuous hidden hinge
- Designed to mount to the front of A-frame style trailers

Diamond Tread

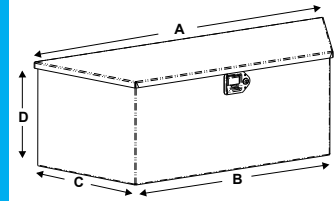

Part No.	Height (D)	Depth (C)	Width (A/B)	Wt. (lb)	Cat.
1701380	14.8	14.4	35.2/21.2	17.5	530 (Y)
1701385	18.3	16.1	33.4/29.22	28	530 (Y)

POLY TRAILER TONGUE WITH HASP

- Constructed of high-density polyethylene
- Designed to mount to the front of A-frame style trailers
- Corrosion and weather resistant stainless steel hasp and hinge made for use with combination lock or padlock (lock sold separately)

Black

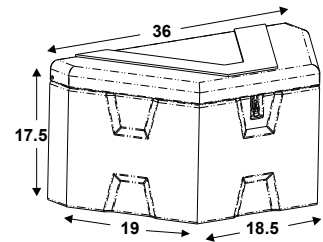

Part No.	Height	Depth	Width	Cubic ft.	Wt. (lb)	Cat.
1701680	18	19	36/18	5.34	21	530 (Y)

White



Part No.	Height	Depth	Width	Cubic ft.	Wt. (lb)	Cat.
1701679	18	19	36/18	5.34	21	530 (Y)

STEEL PUMP BOX AND BATTERY BOX FOR DUMP-TRAILERS

- Durable 15-gauge steel toolbox with gloss black powder-coated finish.
- Predrilled holes with protective exit grommet for cables.
- Locking stainless steel paddle latch with 2 keys.
- Continuous stainless steel hinge.
- Weather-resistant seals keep moisture and dirt out of the tool box.
- Aircraft-grade cable protects the lid and hinge.
- Made in the USA.

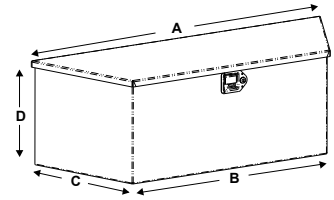

Part No.	Height (D)	Depth (C)	Width (A/B)	Wt. (lb)	Cat.
1701283*	12.4	17.8	31.1/14.6	17.5	530 (Y)

Gloss Black



*** NEW PRODUCTS**



Class 8 Boxes



WideOpen™ Box Features



Locking, polished stainless steel T-handle latch



Non-slip (grip strut) steps and stainless steel continuous hidden hinge

WIDOPEN™ STEP BOXES

- Provides frame steps with built-in storage space
- Universal design fits Peterbilt®, Kenworth®, International®, Freightliner®, Western-Star®, Volvo®, and Mack® trucks
- Non-slip (grip strut) steps
- .125" smooth aluminum construction
- Automotive D-bulb seal protects from the elements
- Locking, polished stainless steel T-handle latch
- Stainless steel continuous hidden hinge
- Corner gussets on door opening provide extra strength
- 1/8" thick integral corner braces provide mounting support
- For heavy loads and toolboxes wider than 18", #1701015 steel mounting brackets are recommended to prevent stress cracks



Part No.	Height	Depth	Width	Wt. (lb)	Cat.
1705280	24	28	12	40	530 (Y)
1705281	24	28	18	47	530 (Y)
1705282	24	28	24	56	530 (Y)
1705283	24	28	30	64	530 (Y)
1705284	24	28	36	76	530 (Y)
1705285	24	28	16	45	530 (Y)
1705286	24	28	22	51	530 (Y)



Class 8 Boxes

STEP BOXES

- Provides frame steps with built-in storage space
- Universal design fits Peterbilt®, Kenworth®, International®, Freightliner®, Western-Star®, Volvo®, and Mack® trucks
- Non-slip (grip punch) steps
- .125" smooth aluminum body
- .100" diamond tread aluminum door
- Automotive D-bulb seal protects from the elements
- Locking die-cast T-handle compression latch
- Stainless steel continuous hidden hinge
- Corner gussets on door opening provide extra strength
- 1/8" thick integral corner braces provide mounting support (for heavy loads and toolboxes wider than 18", #1701015 steel mounting brackets are recommended to prevent stress cracks)



1705180 open



1705180

Part No.	Height	Depth	Width	Wt. (lb)	Cat.
1705180	24	28	12	40	530 (Y)
1705181	24	28	18	46	530 (Y)
1705182	24	28	24	56	530 (Y)
1705183	24	28	30	66	530 (Y)

FRAME STEPS

- Grip strut provides superior traction even in inclement weather
- Universal design fits Peterbilt®, Kenworth®, International®, Freightliner®, Western-Star®, Volvo®, and Mack® trucks
- Corrosion resistant aluminum construction with .188 in. thick sides for years of dependable service
- Universal 4-bolt mounting pattern is easy to install on most semi truck frames

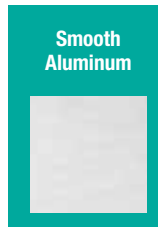

5239018

Part No.	Height	Depth	Width	Wt. (lb)	Cat.
5239012	24	28	12	12	523 (Y)
5239018	24	28	18	13	523 (Y)
5239024	24	28	24	14	523 (Y)

IN-FRAME BOXES

- Mounts between truck frame rails
- Universal design fits Peterbilt®, Kenworth®, International®, Freightliner®, Western-Star®, Volvo®, and Mack® trucks
- Body constructed of .100" smooth aluminum
- .125" Diamond tread aluminum lid
- Built-in rain gutter with automotive bulb seal
- Adjustable stainless steel latch for use with combination lock or padlock (sold separately)
- Full width stainless steel hinge
- Includes Mounting Kit
- Universal Mounting Kit (1705399) is also available separately for purchase

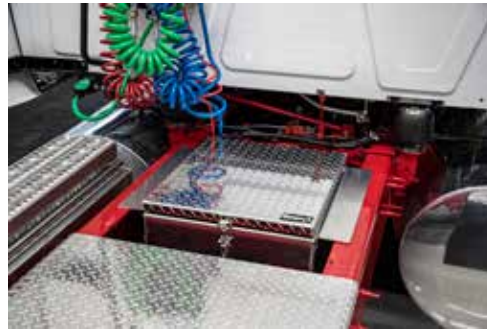

Part No.	Height	Depth	Width	Wt. (lb)	Cat.
1705384	9	22	30	42	530 (Y)
1705381†	12	24	32	52	530 (Y)

†Includes notched center channel to accommodate driveline or accessories

CHAIN HOLDER

- Constructed of structural steel with aluminum diamond tread cover
- TIG welded
- Pre-drilled mounting holes
- Hinged diamond plate cover comes with lock hasp for secure use
- Keeps tire chains securely in place

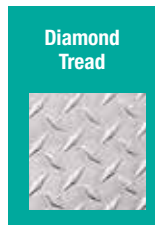

Part No.	Height	Depth	Width	Wt. (lb)	Cat.
5910024	9	7.5	24	34	591 (N)

Parts & Accessories

Universal Mounting Kit for Crossover and Saddle Truck Tool Boxes

- Universal design; can be used with any brand Crossover, Saddle or Gull Wing Truck Tool Box; works with any brand Pick-Up Truck
- Quickly install your crossover truck tool box with this 2-piece hardware set
- Constructed of durable materials to prevent corrosion
- Kit Contains: corrosion-resistant aluminum J-hooks and anti-rust 304-grade stainless steel washers and bolts

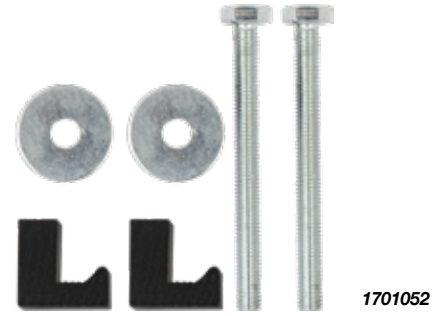

Part No.	Description	Wt. (lb)	Cat.
1701052	Universal Mounting Kit for Crossover, Saddle, and Gull Wing Truck Tool Boxes	.33	530 (Y)

Topsider Mounting Hardware Kits

- Quickly and securely attach your topsider truck tool box to your truck bed rails
- Constructed of durable materials to prevent corrosion
- Kit contains: two powder-coated steel leg brackets, j-bolts with fasteners, and a rubber pad to protect the truck bed rails



Part No.	Color	Wt. (lb)	Cat.
3005318	Black	8	531 (Y)
3004604	White	8	531 (Y)

Lo-sider Mounting Hardware Kits

- Quickly and securely attach your topsider truck tool box to your truck bed rails
- Constructed of durable materials to prevent corrosion
- Kit contains: two powder-coated steel leg brackets, j-bolts with fasteners, and a rubber pad to protect the truck bed rails

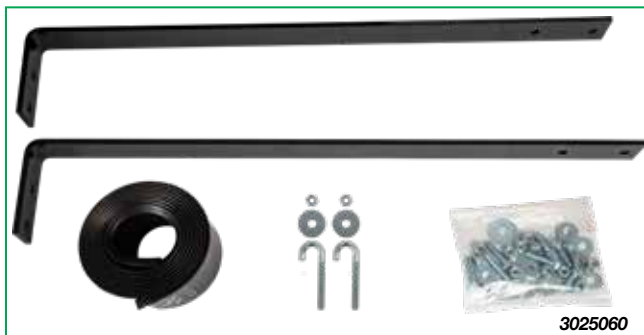

Part No.	Color	Wt. (lb)	Cat.
3025060	Black	8	531 (Y)

Shelf Kit

- Universal design works with any brand underbody or underbed truck tool box.
- Shelf adjusts to three different heights, optimizing storage space inside your truck box.
- Constructed from durable, 16-gauge galvanized steel.
- No tools required for assembly or installation.
- Designed for underbody truck tool boxes measuring 18" tall x 18" wide. Select the length that matches the length of your tool box
- Made in USA



Part No.	Height(in)	Depth(in)	Width(in)	Wt. (lbs.)	Cat.
1701072*	18	18	36	17	530
1701077*	18	18	48	19	530
1701082*	18	18	60	22	530

Heavy Duty Truck Tool Box Liner

- Roll Length is 18" wide by 16' long
- Universal design; can be used with any brand Truck Tool Box, Tool Chest, Garage, Shop, Mechanic or Utility Cabinet, Cart, or Workbench
- Non-slip design; holds tools and gear firmly in place
- Non-adhesive; easily removable and leaves no sticky residue on surfaces
- Non-absorbent; grease and oil resistant; washable and easy to clean
- Grid design; easily cut to fit a variety of storage spaces



Part No.	Depth (in)	Width (in)	Wt. (lb)	Cat.
1701062	16	18	3.42	591 (Y)

Universal Heavy-Duty Interlocking Dry-Mat Floor Tile And Shelf Liner

- Multi-Purpose. Upgrade your garage, trailer, or workshop, or use as a shelf liner in vans, work trucks, service bodies, or inside truck tool boxes.
- Tool-Free Installation. The 12" x 12" tiles snap together with ease.
- Anti-Slip Design. The automotive-grade recycled plastic tiles provide excellent traction, along with added cushion and support for your feet.
- Easy to Clean. Remove oil, dirt, dust, or other spills with a hose or shop vac.
- Finished Border. The male and female beveled-edge pieces (sold separately) provide a professional finish.

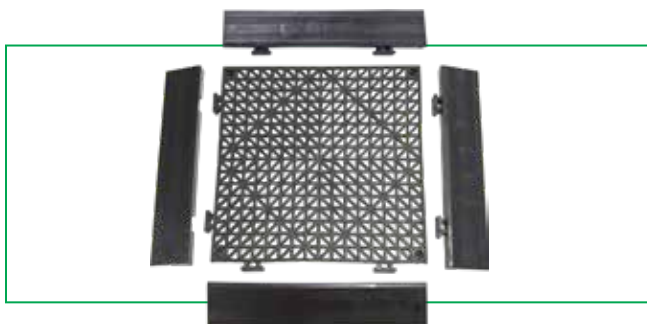

Part No.	Description	Dim	Wt. (lbs.)	Cat.
DM1212B	Tile	12" x 12"	1.42	880 (N)
DM0212BF	Female Edge	2" x 12"	0.33	880 (N)
DM0212BM	Male Edge	2" x 12"	0.35	880 (N)

* **NEW** PRODUCTS

Parts & Accessories

Die Cast Compression Latch



- Strong, secure compression operation
- Latch is secure and stays shut with the adjustable cam action roller engagement
- Corrosion-resistant powder-coated housing
- Corrosion-resistant chrome plated T-handle
- Adjustable cam, from .850 in. to 1.320 in. (No tools required for adjustment)

***Replacement for Buyers boxes using L8816 and L3890RLS latch**

Part No.	Description	Wt. (lbs.)	Cat.
LL9000	Single Point, Compression Latch with Blind Studs, 1/2" Gasket and Cylinder with keys included	2.04	510 (N)
LL90003	3-Point, Compression Latch with Blind Studs, 1/2" Gasket and Cylinder with keys included	2.04	510 (N)

Heavy-Duty Standard Size Flush Mount Folding T-handle Latches

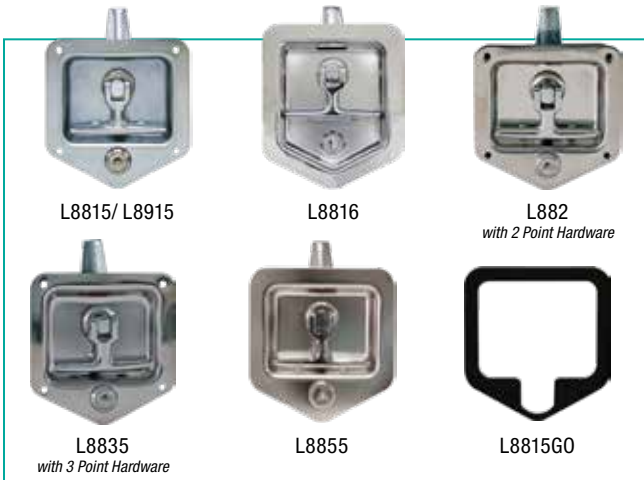

- Polished Stainless steel
- Available in single, double or triple point contact to address most applications
- Adjustable cam from 1.25" to 2" to accommodate door thicknesses
- Designed to mount into a 3.75" x 4" recess opening.
(L8816 fits into 4.375" x 3.5" recess opening)



Part No.	Description	Wt. (lbs.)	Cat.
L882502	34" Replacement Rods for 2 and 3 point latches	105	510 (N)

Part No.	Description	Wt. (lbs.)	Cat.
L8815	Stainless Steel T-Handle Latch with Mounting Holes, Cylinder & Keys Included	1.25	510 (N)
L8816	Tall Flush Mount T-Handle Latch with Blind Studs, Cylinder & Keys Included	1.50	510 (N)
L8915	Zinc Plated Stainless Steel T-Handle Latch with Mounting Holes, Cylinder & Keys Included	1.25	510 (N)
L8825	Standard Size 2 Point T-Handle Latch with Mounting Holes, Cylinder & Keys Included	2.50	510 (N)
L8835	Standard Size 3 Point T-Handle Latch with Mounting Holes, Cylinder & Keys Included	2.75	510 (N)
L8855	Standard Size Flush Mount T-Handle Latch with Blind Studs, Cylinder & Keys Included	1.26	510 (N)
L8815G0	Replacement Gasket For L8815, L8855, and L8915	0.01	510 (N)

Poly Underbody Replacement Latch



- Polished Stainless steel
 - 3-Point latch
 - Adjustable cam from 0.25" to 1.6"
 - Designed to mount into a 4-3/8" x 3-1/2" recess opening
- *Replacement for Buyers poly underbody boxes only, not compatible with standard underbody toolboxes**



Part No.	Description	Wt. (lbs.)	Cat.
L8816R	3-Point Latch Folding-T Handle, with Roller	1.43	510 (N)
L882502	34" Replacement Rods for 2 and 3 point latches	105	510 (N)

Mini Size Tear Drop Latch



- Ideal for use on toolboxes and other small compartment doors
- Polished stainless steel finish
- Locking version includes cylinder and two keys

Part No.	Description	Face Dims. (HxW)	Wt. (lbs.)	Cat.
8000SSL	Stainless Steel Mini Size Tear Drop Style Latch (Locking)	4.38" x 3.25"	0.57	510 (N)
8000SSN	Stainless Steel Mini Size Tear Drop Style Latch (Non-Locking)	4.38" x 3.25"	0.55	510 (N)

Standard Size Single-Point Rotary Paddle Latch



- Polished stainless steel
- Hidden studs
- Includes gasket, cylinder and keys
- Includes hasp for alternative lock; requires 7/16" diameter pad lock shank (not included)

Part No.	Description	Face Dims. (HxW)	Wt. (lbs.)	Cat.
L3890RLS	Stainless Steel Rotary Single Point Paddle Latch, 1/4" Striker	5.5" x 4.75"	1.40	510 (N)
3005833	Striker Plate/Bracket; for use with L3890RLS	-	0.26	530-1 (N)

Stainless Steel Adjustable Draw Latch



- Polished stainless steel
- Adjustable latch for use with combination lock or padlock (sold separately)
- Adjust the latching distance to compensate for gasket and panel misalignment
- Heavy-duty lever-action latch provides door-closing leverage for heavier gasketed door applications like toolboxes and other small compartment doors

Part No.	Description	Wt. (lb)	Cat.
3049352	Stainless Steel Adjustable Draw Latch	.52	530-1

Cylinder and Key

- For standard and mini size latches
- Various keys available



Part No.	Description	Wt. (lbs.)	Cat.
19CH545	Cylinder and Key	0.09	510 (N)
88CH510	Cylinder Lock with 2 Keys	0.13	510 (N)
39LL71	Cylinder and Key	0.09	510 (N)
L38RLSCH545	Cylinder for L3885RLS Latch	0.25	510 (N)
88CH545	Cylinder for L8815/L8915/L8816 Latch	0.25	510 (N)
CDC01Z	Zinc Die Cast Cylinder Dust Cover (Works with all Cylinders and Keys Listed Above)	0.05	510 (N)

Push Button Lock and Key

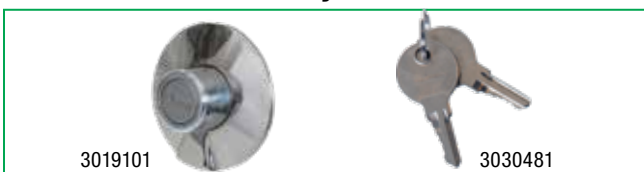

Part No.	Description	Wt. (lbs.)	Cat.
3019101	Push Button Lock with Key	0.68	530-1 (N)
3030481	Spare Key for Push Button Lock	0.03	530-1 (N)

Parts & Accessories

Universal Aluminum Cam-Action Lock Kit

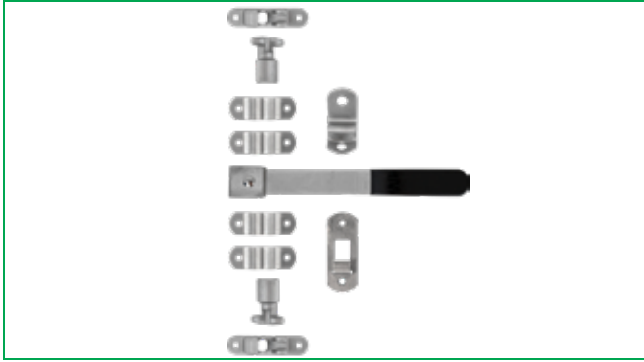

- Kit contains aluminum cams and keepers, rod guides, a plastic-coated handle, and a hasp that allows for the use of a personal padlock
- Aluminum pipe is not included.

Part No.	Description	Wt. (lbs.)	Cat.
3052380	Universal Aluminum Cam-Action Lock Kit	3.31	510 (N)

Hinged Security Hasp



- Mounting screws included for easy installation.
- 17 Ga zinc-plated steel for strength and corrosion resistance.
- Hasp can be secured by adding lock (not included) in padlock eye.

Part No.	Length (in)	Width (in)	Wt. (lb)	Cat.
SH35	3.5	1.5	0.19	510 (N)
SH36	4.63	1.44	0.31	510 (N)

Replacement Tray for 2020+ Crossover Truck Tool Boxes



- Oversized powder-coated steel tray with dividers
- 3 Dividers are removable for flexible storage
- For use with the newly redesigned crossover and gull wing tool boxes (page 74-77)

Part No.	Depth (in)	Width (in)	Wt. (lb)	Cat.
3043331	15.375	18	7.64	530 (Y)
3047140	15.375	25	10.56	530 (Y)

Gas Shocks



- Dampened extension
- Undampened compression
- Black powder-coated cylinder

Part No.	Extended Length	Compressed Length	Stroke	Rod Diameter	Cylinder Diameter	Ball Socket Diameter	Force Rating (lbs.)	Wt. (lbs.)	Cat.
3045502	17"	10"	7"	6mm	15mm	10mm	20	0.42	530-1 (N)
3045504	12"	8"	4"	6mm	15mm	10mm	25	0.27	530-1 (N)
3045506	12"	8"	4"	6mm	15mm	10mm	30	0.43	530-1 (N)
3045508	12"	8"	4"	6mm	15mm	10mm	40	0.27	530-1 (N)
3045512	12"	8"	4"	6mm	15mm	10mm	60	0.27	530-1 (N)
3045514	12"	8"	4"	6mm	15mm	10mm	80	0.42	530-1 (N)
3040770	17.10"	10.80"	6.30"	8mm	18mm	10mm	97	0.56	530-1 (N)
3023460	19.63"	11.63"	8"	9.98mm	21.59mm	10mm	250	0.85	903-2 (N)
3028786	13.93"	8.5"	5.5"	8mm	18mm	10mm	35	0.51	520 (N)
3008745	10mm Ball Stud (Sold Separately except for 3028786)							0.03	530-1 (N)
FNE031018034	Nylock Nut for Ball Stud (Sold Separately except for 3023460)							0.01	530-1 (N)

Trailer Tongue Display Stand



- Works with all Buyers Products Trailer Tongue Tool Boxes
- Contact your Buyers Products sales representative for additional details
- Not intended for use as a retail selling shelf fixture



Part No.	Description	Cat.
3047012	Trailer Tongue Display Stand	994

Underbody Truck Tool Box Display Stand



- Works with all Buyers Products 18x18x36 Underbody Truck boxes
- Contact your Buyers Products sales representative for additional details
- Not intended for use as a retail selling shelf fixture



Part No.	Description	Cat.
99170	Underbody Truck Tool Box Display Stand	994

Crossover and Gull Wing Display Stand



- Works with Buyers Products Crossover and Gull Wings truck tool boxes that are 18x20x71
- Contact your Buyers Products sales representative for additional details
- Not intended for use as a retail selling shelf fixture



Part No.	Description	Cat.
3052089	Crossover and Gull Wing Display Stand	994

Underbody Replacement Parts

PART NO.	DOORS	LATCHES	LANYARDS
1702100	1702100DOOR	L3890RLS	3003081
1702103	1702103DOOR	L3890RLS	3003081
1702105	1702105DOOR	L3890RLS	3003081
1702110	1702110DOOR	L3890RLS	3003081
1702115	1702115DOOR	L3890RLS	3003081
1702200	1702200DOOR	L3890RLS	3003081
1702203	1702203DOOR	L3890RLS	3003081
1702205	1702205DOOR	L3890RLS	3003081
1702210	1702210DOOR	L3890RLS	3003081
1702215	1702215DOOR	L3890RLS	3003081
1702295	1702295DOOR	L8816	3003081
1702300	1702300DOOR	L8816	3003081
1702303	1702303DOOR	L8816	3003081
1702305	1702305DOOR	L8816	3003081
1702306	1702306DOOR	LL9003	-
1702310	1702310DOOR	L8816	3003081
1702311	1702311DOOR	LL9003	-
1702315	1702315DOOR	L8816	3003081
1702317	1702317DOOR	L8816	3003081
1702325	1702325DOOR	L8816	3003081
1702400	1702400DOOR	L8816	3003081
1702403	1702403DOOR	L8816	3003081
1702405	1702405DOOR	L8816	3003081
1702406	1702406DOOR	LL90003	-
1702410	1702410DOOR	L8816	3003081
1702411	1702411DOOR	LL90003	-
1702415	1702415DOOR	L8816	3003081
1702417	1702417DOOR	L8816	3003081
1702500	1702500DOOR	LL9000	3003081
1702503	1702503DOOR	LL9000	3003081
1702505	1702505DOOR	LL9000	3003081
1702510	1702510DOOR	LL9000	3003081
1702595	1702595DOOR	LL9000	3003081
1702600	1702600DOOR	LL9000	3003081
1702603	1702603DOOR	LL9000	3003081
1702605	1702605DOOR	LL9000	3003081
1702610	1702610DOOR	LL9000	3003081
1702650	1702650DOOR	LL9000	-
1702653	1702653DOOR	LL9000	-
1702655	1702655DOOR	LL9000	-
1702660	1702660DOOR	LL9000	-
1702700	1702700DOOR	LL9000	3003081
1702703	1702703DOOR	LL9000	3003081
1702705	1702705DOOR	LL9000	3003081
1702710	1702710DOOR	LL9000	3003081
1702715	1702715DOOR	LL9000	3003081
1702725	1702705DOOR	LL9000	3003081
1702900	1702900DOOR	L8816	3003081
1702905	1702905DOOR	L8816	3003081
1702910	1702910DOOR	L8816	3003081
1703100	1703100DOOR	L3890RLS	3003480
1703103	1703103DOOR	L3890RLS	3003480
1703150	1703150DOOR	L3890RLS	3003480
1703203	1703203DOOR	L3890RLS	3003480
1703205	1703205DOOR	L3890RLS	3003480
1703300	1703300DOOR	L8816	3003480
1703303	1703303DOOR	L8816	3003480
1703304	1703303DOOR	L8816	3003480
1703305	1703305DOOR	L8816	3003480
1703310	1703310DOOR	L8816	3003480
1703312	1703312DOOR	L8816	3003480
1703320	1703320DOOR	L8816	3003480
1703322	1703322DOOR	L8816	3003480
1703324	1703324DOOR	L8816	3003480
1703326	1703326DOOR	L8816	3003480
1703328	1703328DOOR	L8816	3004556
1703330	1703330DOOR	L8816	3003480
1703349	1703349DOOR	L8816	3003480
1703350	1703350DOOR	L8816	3003480
1703351	1703349DOOR	L8816	3003480
1703352	1703350DOOR	L8816	3003480
1703353	1703353DOOR	L8816R	3003480
1703355	1703303DOOR	L8816	3003480
1703400	1703400DOOR	L8816	3003480
1703403	1703403DOOR	L8816	3003480

PART NO.	DOORS	LATCHES	LANYARDS
1703404	1703403DOOR	L8816	3003480
1703405	1703405DOOR	L8816	3003480
1703495	1703495DOOR	L3890RLS	3003081
1703700	1703700DOOR	LL9000	3003480
1703703	1703703DOOR	LL9000	3003480
1703705	1703705DOOR	LL9000	3003480
1703900	1703900DOOR	L8816	3003480
1704300	1704300DOOR	L8816	3004713
1704303	1704303DOOR	L8816	3004713
1704305	1704305DOOR	L8816	3004713
1704310	1704310DOOR	L8816	3004713
1704315	1704315DOOR	L8816	3004713
1704400	1704400DOOR	L8816	3004713
1704403	1704403DOOR	L8816	3004713
1704405	1704405DOOR	L8816	3004713
1704410	1704410DOOR	L8816	3004713
1704415	1704415DOOR	L8816	3004713
1704600	3047158	LL9000	3004713
1704603	3047159	LL9000	3004713
1704610	3010773	LL9000	3004713
1704615	3047195	LL9000	3004713
1704705	1704705DOOR	LL9000	3004713
1704710	1704710DOOR	LL9000	3003081
1704715	1704715DOOR	LL9000	3003081
1705100	1705100DOORB	LL9000	3003081
1705101	1705101DOORB	LL9000	3003081
1705102	1705102DOORB	LL9000	3003081
1705103	1705103DOORB	LL9000	3003081
1705105	1705105DOORB	LL9000	3003081
1705110	1705110DOORB	LL9000	3003081
1705115	1705115DOORB	LL9000	3003081
1705118	1705118DOORB	LL9000	3024237
1705119	-	LL9000	3003081
1705120	1705110DOORB	LL9000	3003081
1705125	-	LL9000	3003081
1705130	1705130DOORB	LL9000	3004713
1705133	1705133DOORB	LL9000	3004713
1705135	1705135DOORB	LL9000	3004713
1705140	1705140DOORB	LL9000	3004713
1705145	1705145DOORB	LL9000	3004713
1705147	1705147DOORB	LL9000	3004713
1705148	1705148DOORB	LL9000	3003480
1705149	1705149DOORB	LL9000	3003480
1705150	1705150DOORB	LL9000	3003480
1705153	1705153DOORB	LL9000	3003480
1705160	1705160DOORB	LL9000	3003480
1706400	1706400DOORB	LL90003	3003784
1706403	1706403DOORB	LL90003	3003784
1706405	1706405DOORB	LL90003	3003784
1706410	1706410DOORB	LL90003	3003784
1706415	1706415DOORB	LL90003	3003784
1706420	1706420DOORB	LL90003	3003784
1706425	1706425DOORB	LL90003	3003784
1706430	1706430DOORB	LL90003	3003784
1706500	1706500DOORB	LL90003	3003784
1706503	1706503DOORB	LL90003	3003784
1706505	1706505DOORB	LL90003	3003784
1706510	1706510DOORB	LL90003	3003784
1706515	1706515DOORB	LL90003	3003784
1706520	1706505DOORB	LL90003	3003784
1706525	1706510DOORB	LL90003	3003784
1706530	1706515DOORB	LL90003	3003784
1706960	-	LL90003	3003784
1706963	-	LL90003	3003784
1706965	-	LL90003	3003784
1706970	-	LL90003	3003784
1706975	-	LL90003	3003784
1706980	-	LL90003	3003784
1706985	-	LL90003	3003784
1706990	-	LL90003	3003784
1707960	-	LL90003	3003784
1707963	-	LL90003	3003784
1707965	-	LL90003	3003784
1707970	-	LL90003	3003784
1707975	-	LL90003	3003784

PART NO.	DOORS	LATCHES	LANYARDS
1707980	-	LL90003	3033784
1707985	-	LL90003	3033784
1707990	-	LL90003	3033784
1708310	1708310DOOR	L8816	3003081
1708410	1702410DOOR	L8816	3003081
1712200	-	LL9000	3003081
1712205	-	LL9000	3003081
1712210	-	LL9000	3003081
1715100	1715100DOORB	LL9000	3003081
1715105	1715105DOORB	LL9000	3003081
1715110	1715110DOORB	LL9000	3003081
1715115	1715115DOORB	LL9000	3003081
1725100	1725100DOOR	LL9000	3003081
1725101	1725101DOORB	LL9000	3003081
1725102	1725102DOORB	LL9000	3003081
1725103	1725103DOORB	LL9000	3003081
1725105	1725105DOOR	LL9000	3003081
1725110	1725110DOOR	LL9000	3003081
1725115	1725115DOORB	LL9000	3003081
1725116	1725116DOORB	LL9000	3003081
1725118	1725118DOORB	LL9000	3024237
1725119	1725119DOORB	LL9000	3003081
1725120	1725120DOORB	LL9000	3003081
1725125	-	LL9000	3003081
1725130	1725130DOOR	LL9000	3004713
1725133	1725133DOORB	LL9000	3004713
1725135	1725135DOOR	LL9000	3004713
1725140	1725140DOOR	LL9000	3004713
1725145	1725145DOORB	LL9000	3004713
1725147	1725147DOORB	LL9000	3004713
1725148	1725148DOORB	LL9000	3003480
1725149	1725149DOORB	LL9000	3003480
1725150	1725150DOORB	LL9000	3003480
1725153	1725153DOORB	LL9000	3003081
1725160	1725160DOORB	LL9000	3003081
1732300	1732300DOOR	LL90003	3024237
1732303	1703203DOOR	L3890RLS	3003480
1732305	1732305DOOR	LL90003	3024237
1732310	1732310DOOR	LL90003	3024237
1732315	-	LL90003	3003081
1732400	1732400DOOR	LL90003	3024237
1732403	1732403DOOR	LL90003	3024237
1732405	1732405DOOR	LL90003	3024237
1732500	1732500DOOR	LL90003	3024237
1732503	1732503DOOR	LL90003	3024237
1732505	1732505DOOR	LL90003	3024237
1732510	1732510DOOR	LL90003	3024237
1734300	1734300DOOR	LL90003	3024238
1734303	1734303DOOR	LL90003	3024238
1734305	1734305DOOR	LL90003	3024238
1734400	1734400DOOR	LL90003	3024238
1734403	1734403DOOR	LL90003	3024238
1734405	1734405DOOR	LL90003	3024238
1734500	1734500DOOR	LL90003	3024238
1734503	1734503DOOR	LL90003	3024238
1734505	1734505DOOR	LL90003	3024238
1735100	1735100DOOR	LL90003	3003081
1735103	1735103DOOR	LL90003	3003081
1735105	1735105DOOR	LL90003	3003081
1735130	1735130DOOR	LL90003	3004713
1735133	1735133DOOR	LL90003	3004713
1735135	1735135DOOR	LL90003	3004713
1742300	1742300DOOR	LL9000	3030806
1742303	1742303DOOR	LL9000	3030806
1742305	1742305DOOR	LL9000	3030806
1742310	1742310DOOR	LL9000	3030806
1742315	1742303DOOR	LL9000	3030806
1742325	1742305DOOR	LL9000	3030806
1742335	1742335DOOR	LL9000	3030806
1742336	1742310DOOR	LL9000	3030806
1744300	1744300DOOR	LL9000	3041851
1744303	1744303DOOR	LL9000	3041851
1744305	1744305DOOR	LL9000	3041851

Barn Door Replacement Parts

PART NO.	DOORS WITH LATCH	DOOR WITHOUT LATCH	LATCHES
1702225	1702225DOORBWLCH	1702225DOORBWLCH	LL9000
1702230	1702230DOORBWLCH	1702230DOORBWLCH	LL9000
1702235	1702235DOORBWLCH	1702235DOORBWLCH	LL90003
1702240	1702240DOORBWLCH	1702240DOORBWLCH	LL90003
1702250	1702250DOORBWLCH	1702250DOORBWLCH	LL90003
1705200	1705200DOORBWLCH	1705200DOORBWLCH	LL90003
1705201	1705201DOORBWLCH	1705201DOORBWLCH	LL90003
1705203	1705203DOORBWLCH	1705203DOORBWLCH	LL90003
1705205	1705205DOORBWLCH	1705205DOORBWLCH	LL90003
1705210	1705210DOORBWLCH	1705210DOORBWLCH	LL90003
1705215	1705215DOORBWLCH	1705215DOORBWLCH	LL90003
1705295	1705295DOORBWLCH	1705295DOORBWLCH	LL9000
1705300	1705300DOORBWLCH	1705300DOORBWLCH	LL9000
1705303	1705303DOORBWLCH	1705303DOORBWLCH	LL90003
1705305	1705305DOORBWLCH	1705305DOORBWLCH	LL90003
1705310	1705310DOORBWLCH	1705310DOORBWLCH	LL90003
1705315	1705315DOORBWLCH	1705315DOORBWLCH	LL90003
1705333	1705333DOORBWLCH	1705333DOORBWLCH	LL90003
1705335	1705335DOORBWLCH	1705335DOORBWLCH	LL90003
1705395	1705395DOORBWLCH	1705395DOORBWLCH	LL9000
1705340	1705340DOORBWLCH	1705340DOORBWLCH	LL90003
1705345	1705345DOORBWLCH	1705345DOORBWLCH	LL90003
1705350	1705350DOORBWLCH	1705350DOORBWLCH	LL90003
1705401	1705401DOORBWLCH	1705401DOORBWLCH	LL9000
1705403	1705403DOORBWLCH	1705403DOORBWLCH	LL9003
1705405	1705405DOORBWLCH	1705405DOORBWLCH	LL90003
1705410	1705410DOORBWLCH	1705410DOORBWLCH	LL90003

PART NO.	DOORS WITH LATCH	DOOR WITHOUT LATCH	LATCHES
1705415	1705415DOORBWLCH	1705415DOORBWLCH	LL90003
1705420	1705420DOORBWLCH	1705420DOORBWLCH	LL90003
1705425	1705425DOORBWLCH	1705425DOORBWLCH	LL90003
1705430	1705430DOORBWLCH	1705430DOORBWLCH	LL90003
1705431	1705431DOORBWLCH	1705431DOORBWLCH	LL9000
1705433	1705433DOORBWLCH	1705433DOORBWLCH	LL9003
1705435	1705435DOORBWLCH	1705435DOORBWLCH	LL90003
1705440	1705440DOORBWLCH	1705440DOORBWLCH	LL90003
1705445	1705445DOORBWLCH	1705445DOORBWLCH	LL90003
1705450	1705450DOORBWLCH	1705450DOORBWLCH	LL90003
1705795	1705795DOORBWLCH	1705795DOORBWLCH	LL9000
1705800	1705800DOORBWLCH	1705800DOORBWLCH	LL9000
1705825	1705825DOORBWLCH	1705825DOORBWLCH	LL9000
1705895	1705895DOORBWLCH	1705895DOORBWLCH	LL9000
1705900	1705900DOORBWLCH	1705900DOORBWLCH	LL9000
1705903	1705903DOORBWLCH	1705903DOORBWLCH	LL9003
1705931	1705931DOORBWLCH	1705931DOORBWLCH	LL9000
1705933	1705933DOORBWLCH	1705933DOORBWLCH	LL9000
1706795	1706795DOORBWLCH	1706795DOORBWLCH	LL9000
1706800	1706800DOORBWLCH	1706800DOORBWLCH	LL9000
1706825	1706825DOORBWLCH	1706825DOORBWLCH	LL9000
1706895	1706895DOORBWLCH	1706895DOORBWLCH	LL9000
1706900	1706900DOORBWLCH	1706900DOORBWLCH	LL9000
1706903	1706903DOORBWLCH	1706903DOORBWLCH	LL9003
1706931	1706931DOORBWLCH	1706931DOORBWLCH	LL9000
1706933	1706933DOORBWLCH	1706933DOORBWLCH	LL9003

CAM Lock Replacement Parts

ALUMINUM DOOR

PART NO.	ROD SIDE DOOR	HASP SIDE DOOR	CAMLOCK HARDWARE KIT
1762600	1762600DOORROD	1762600DOORHASP	3052380
1762603	1762603DOORROD	1762603DOORHASP	3052380
1762606	1762606DOORROD	1762606DOORHASP	3052380
1762609	1762609DOORROD	1762609DOORHASP	3052380
1762621	1762621DOORROD	1762621DOORHASP	3052380
1762624	1762624DOORROD	1762624DOORHASP	3052380
1762627	1762627DOORROD	1762627DOORHASP	3052380
1762630	1762630DOORROD	1762630DOORHASP	3052380
1762639	1762639DOORROD	1762639DOORHASP	3052380
1762642	1762642DOORROD	1762642DOORHASP	3052380
1762645	1762645DOORROD	1762645DOORHASP	3052380
1762648	1762648DOORROD	1762648DOORHASP	3052380

STAINLESS STEEL DOOR

PART NO.	ROD SIDE DOOR	HASP SIDE DOOR	CAMLOCK HARDWARE KIT
1763100	1763100DOORROD	1763100DOORHASP	3052380
1763103	1763103DOORROD	1763103DOORHASP	3052380
1763106	1763106DOORROD	1763106DOORHASP	3052380
1763121	1763121DOORROD	1763121DOORHASP	3052380
1763124	1763124DOORROD	1763124DOORHASP	3052380
1763127	1763127DOORROD	1763127DOORHASP	3052380
1763139	1763139DOORROD	1763139DOORHASP	3052380
1763142	1763142DOORROD	1763142DOORHASP	3052380
1763145	1763145DOORROD	1763145DOORHASP	3052380

PART NO.	PAGE NO.	PART NO.	PAGE NO.	PART NO.	PAGE NO.	PART NO.	PAGE NO.	PART NO.	PAGE NO.
1701000.....	35	1702403.....	12	1703312.....	11	1705166.....	30	1705910.....	24
1701001.....	35	1702405.....	12	1703320.....	11	1705169.....	30	1705915.....	24
1701005.....	34	1702406.....	13	1703321.....	11	1705180.....	88	1705920.....	24
1701005B.....	34	1702410.....	12	1703322.....	11	1705181.....	88	1705925.....	24
1701006.....	34	1702411.....	13	1703324.....	11	1705182.....	88	1705930.....	24
1701006B.....	34	1702415.....	12	1703326.....	11	1705183.....	88	1705931.....	24
1701010.....	34	1702417.....	12	1703328.....	11	1705200.....	29	1705933.....	24
1701010B.....	34	1702425.....	12, 15	1703330.....	11	1705201.....	29	1705935.....	24
1701011.....	34	1702500.....	19	1703349.....	11	1705203.....	29	1705940.....	24
1701011B.....	34	1702503.....	19	1703350.....	11	1705205.....	29	1705945.....	24
1701012.....	34	1702505.....	19	1703351.....	13	1705210.....	29	1705950.....	24
1701015.....	34	1702510.....	19	1703352.....	13	1705215.....	29	1706400.....	22
1701016.....	34	1702595.....	17	1703353.....	11	1705280.....	87	1706403.....	22
1701030.....	35	1702600.....	17	1703355.....	13	1705281.....	87	1706405.....	22
1701031.....	35	1702603.....	17	1703400.....	12, 63	1705282.....	87	1706410.....	22
1701040.....	35	1702605.....	17	1703403.....	12, 63	1705283.....	87	1706415.....	22
1701041.....	35	1702610.....	17	1703404.....	13, 63	1705284.....	87	1706420.....	22
1701052.....	90	1702650.....	18	1703495.....	12	1705285.....	87	1706425.....	22
1701062.....	91	1702653.....	18	1703700.....	16	1705286.....	87	1706430.....	22
1701072.....	91	1702655.....	18	1703703.....	16	1705295.....	28	1706500.....	23
1701077.....	91	1702660.....	18	1703705.....	16	1705300.....	28	1706503.....	23
1701082.....	91	1702700.....	16	1703900.....	12, 63	1705303.....	28	1706505.....	23
1701280.....	84	1702703.....	16	1704300.....	11	1705305.....	28	1706510.....	23
1701281.....	84	1702705.....	16	1704303.....	11	1705310.....	28	1706515.....	23
1701285.....	84	1702710.....	16	1704305.....	11	1705315.....	28	1706520.....	23
1701351.....	40	1702715.....	16	1704310.....	11	1705325.....	28	1706525.....	23
1701356.....	40	1702725.....	16	1704315.....	11	1705333.....	28	1706530.....	23
1701361.....	40	1702840.....	39	1704320.....	11, 15	1705335.....	28	1706960.....	22
1701363.....	40	1702840TRAY.....	39	1704400.....	12	1705340.....	28	1706963.....	22
1701364.....	40	1702850.....	39	1704403.....	12	1705345.....	28	1706965.....	22
1701365.....	40	1702850TRAY.....	39	1704405.....	12	1705350.....	28	1706970.....	22
1701380.....	84	1702860.....	39	1704410.....	12	1705381.....	89	1706975.....	22
1701385.....	84	1702860TRAY.....	39	1704415.....	12	1705384.....	89	1706980.....	22
1701551.....	41	1702880.....	39	1704420.....	12, 15	1705395.....	24	1706985.....	22
1701556.....	41	1702880TRAY.....	39	1704600.....	17	1705401.....	24	1706990.....	22
1701561.....	41	1702890.....	39	1704603.....	17	1705403.....	24	1707020.....	82
1701563.....	41	1702890TRAY.....	39	1704605.....	17	1705405.....	24	1708310.....	11
1701564.....	41	1702895.....	39	1704610.....	17	1705410.....	24	1708410.....	12
1701565.....	41	1702895TRAY.....	39	1704615.....	17	1705415.....	24	1708710.....	16
1701568.....	41	1702900.....	12	1704700.....	16	1705420.....	24	1709410.....	75
1701679.....	84	1702905.....	12	1704703.....	16	1705425.....	24	1709415.....	75
1701680.....	84	1702910.....	12	1704705.....	16	1705430.....	24	1709420.....	75
1701770.....	40	1702920.....	39	1704710.....	16	1705431.....	24	1709425.....	75
1702100.....	14	1702920TRAY.....	39	1704715.....	16	1705433.....	24	1709430.....	75
1702103.....	14	1702940.....	39	1705100.....	30	1705435.....	24	1710410.....	77
1702105.....	14	1702940TRAY.....	39	1705101.....	30	1705440.....	24	1710413.....	77
1702110.....	14	1702950.....	39	1705102.....	30	1705445.....	24	1710420.....	77
1702115.....	14	1702950TRAY.....	39	1705103.....	30	1705450.....	24	1710423.....	77
1702200.....	14	1702960.....	39	1705105.....	30	1705640.....	44	1711010.....	79
1702203.....	14	1702960TRAY.....	39	1705110.....	30	1705641.....	45	1711020.....	79
1702205.....	14	1702965.....	16	1705113.....	30	1705650.....	44	1711025.....	79
1702210.....	14	1702980.....	39	1705115.....	30	1705651.....	45	1711030.....	79
1702215.....	14	1702980TRAY.....	39	1705118.....	30	1705660.....	44	1712010.....	81
1702225.....	29	1702990.....	39	1705119.....	30	1705795.....	28	1712020.....	81
1702230.....	29	1702990TRAY.....	39	1705120.....	30	1705800.....	28	1712030.....	81
1702235.....	29	1703000.....	39	1705125.....	30	1705803.....	28	1712035.....	81
1702240.....	29	1703000TRAY.....	39	1705127.....	30	1705805.....	28	1712110.....	81
1702250.....	29	1703020.....	39	1705130.....	30	1705810.....	28	1712120.....	81
1702295.....	11	1703020TRAY.....	39	1705133.....	30	1705815.....	28	1712200.....	32
1702300.....	11	1703100.....	14	1705135.....	30	1705825.....	28	1712205.....	32
1702303.....	11	1703103.....	14	1705140.....	30	1705833.....	28	1712210.....	32
1702305.....	11	1703150.....	14	1705145.....	30	1705835.....	28	1712230.....	83
1702306.....	13	1703203.....	14	1705147.....	30	1705840.....	28	1712240.....	83
1702310.....	11	1703205.....	14	1705148.....	30	1705845.....	28	1712250.....	83
1702311.....	13	1703300.....	11, 63	1705149.....	30	1705850.....	28	1712255.....	83
1702315.....	11	1703303.....	11, 63	1705150.....	30	1705895.....	24	1712260.....	83
1702317.....	11	1703304.....	13, 63	1705153.....	30	1705900.....	24	1713005.....	79
1702325.....	11	1703305.....	11	1705160.....	30	1705903.....	24	1713015.....	79
1702400.....	12	1703310.....	11	1705163.....	30	1705905.....	24	1713025.....	79

PART NO.	PAGE NO.	PART NO.	PAGE NO.	PART NO.	PAGE NO.	PART NO.	PAGE NO.	PART NO.	PAGE NO.
1713030.....	79	1725135.....	31	1751651.....	42	3030481.....	93	BP826524B.....	51
1713035.....	79	1725140.....	31	1751656.....	42	3035896.....	67	BP826524P.....	51
1715100.....	31	1725145.....	31	1751661.....	42	3037014.....	65	BP826524W.....	51
1715105.....	31	1725147.....	31	1751663.....	42	3037014A.....	65	BP827024.....	49
1715110.....	31	1725148.....	31	1751664.....	42	3040770.....	94	BP827054.....	61
1715115.....	31	1725149.....	31	1751665.....	42	3043331.....	94	BP855524B.....	51
1717100.....	33	1725150.....	31	1751668.....	42	3045502.....	94	BP855524BSST.....	51
1717105.....	33	1725153.....	31	1752151.....	42	3045504.....	94	BP855524P.....	51
1717110.....	33	1725160.....	31	1752156.....	42	3045506.....	94	BP855524W.....	51
1720410.....	77	1725640.....	44	1752161.....	42	3045508.....	94	BP855548B.....	61
1720413.....	77	1725641.....	45	1752163.....	42	3045512.....	94	BP855548W.....	61
1720420.....	77	1725650.....	44	1752164.....	42	3045514.....	94	BP855924.....	53
1720423.....	77	1725651.....	45	1752165.....	42	3045516.....	94	BP855924B.....	55
1721010.....	79	1725660.....	44	1752168.....	42	3047012.....	95	BP855924BSST.....	55
1721020.....	79	1729410.....	75	1752799.....	8	3047140.....	94	BP855924P.....	55
1721025.....	79	1729415.....	75	1752800.....	8	3049352.....	93	BP855924W.....	55
1721030.....	79	1729420.....	75	1752803.....	8	3052089.....	95	BP925824.....	49
1721351.....	40	1729425.....	75	1752805.....	8	3052380.....	94	BP925824B.....	51
1721356.....	40	1729430.....	75	1752810.....	8	39LL71.....	93	BP925824P.....	51
1721361.....	40	1731020.....	79	1752815.....	8, 38	5239012.....	88	BP925824W.....	51
1721363.....	40	1732300.....	15	1752825.....	8, 38	5239018.....	88	BP964824.....	59
1721364.....	40	1732303.....	15	1752835.....	8, 38	5239024.....	88	BP964824B.....	59
1721365.....	40	1732305.....	15	1752836.....	8, 38	5621002.....	67	BP964824BLL.....	59
1721551.....	41	1732310.....	15	1753151.....	43	562109166.....	67	BP964824P.....	59
1721556.....	41	1732315.....	15	1753161.....	43	562133202.....	67	BP964824W.....	59
1721561.....	41	1732320.....	15	1753163.....	43	5621827.....	67	BP964824WLL.....	59
1721563.....	41	1732400.....	15	1753165.....	43	5621928.....	67	BP965724.....	57
1721564.....	41	1732403.....	15	1753168.....	43	5622029.....	66	BP965724B.....	57
1721565.....	41	1732405.....	15	1754800.....	8	5622120.....	66	BP965724W.....	57
1721568.....	41	1732410.....	15	1754803.....	8	5622436.....	67	CDC01Z.....	93
1721770.....	40	1732415.....	15	1754805.....	8	5622537.....	67	DM0212BF.....	91
1722010.....	81	1732500.....	15	1754807.....	8	5622840.....	66	DM0212BM.....	91
1722351.....	40	1732503.....	15	1754809.....	8, 38	5622941.....	66	DM1212B.....	91
1722356.....	40	1732505.....	15	1754811.....	8, 38	5623654.....	67	FNE031018034.....	94
1722361.....	40	1732510.....	15	1754814.....	8, 38	5623755.....	67	L3890RLS.....	93
1722363.....	40	1733005.....	79	1754817.....	8, 38	5623856.....	66	L38RLSCH545.....	93
1722364.....	40	1733015.....	79	1762600.....	27	5623957.....	66	L8815.....	92
1722365.....	40	1733025.....	79	1762603.....	27	5624872.....	67	L8815G0.....	92
1722410.....	77	1733030.....	79	1762606.....	27	5624973.....	67	L8816.....	92
1722413.....	77	1733035.....	79	1762609.....	27	5625276.....	66	L8816R.....	92
1722420.....	77	1734300.....	15	1762621.....	27	5625377.....	66	L8825.....	92
1722423.....	77	1734303.....	15	1762624.....	27	5626090.....	67	L882502.....	92
1722551.....	41	1734305.....	15	1762627.....	27	5626191.....	67	L8835.....	92
1722556.....	41	1734400.....	15	1762630.....	27	56296144.....	67	L8855.....	92
1722561.....	41	1734403.....	15	1762639.....	27	56297145.....	67	L8915.....	92
1722563.....	41	1734405.....	15	1762642.....	27	5910024.....	89	LL9000.....	92
1722564.....	41	1734500.....	15	1762645.....	27	8000SSL.....	93	LL90003.....	92
1722565.....	41	1734503.....	15	1762648.....	27	8000SSN.....	93	SH35.....	93
1722568.....	41	1734505.....	15	1763100.....	27	88CH510.....	93	SH36.....	93
1722770.....	40	1735100.....	32	1763103.....	27	88CH545.....	93	UB623516.....	64
1723005.....	79	1735101.....	32	1763106.....	27	9031100.....	83		
1723015.....	79	1735103.....	32	1763121.....	27	9031105.....	83		
1723025.....	79	1735105.....	32	1763124.....	27	9031110.....	83		
1723030.....	79	1735110.....	32	1763127.....	27	99170.....	95		
1723035.....	79	1735115.....	32	1763139.....	27	BP141624.....	63		
1725100.....	31	1735116.....	32	1763142.....	27	BP242486.....	71		
1725101.....	31	1735119.....	32	1763145.....	27	BP242486B.....	71		
1725102.....	31	1735120.....	32	19CH545.....	93	BP242486W.....	71		
1725103.....	31	1735125.....	32	3004604.....	90	BP242496.....	71		
1725105.....	31	1735130.....	32	3005318.....	90	BP242496B.....	71		
1725110.....	31	1735133.....	32	3005833.....	93	BP242496W.....	71		
1725115.....	31	1735135.....	32	3008086.....	64	BP824624.....	53		
1725116.....	31	1735140.....	32	3008745.....	94	BP824624B.....	55		
1725118.....	31	1735145.....	32	3009122.....	65	BP824624P.....	55		
1725119.....	31	1739410.....	75	3009123.....	65	BP824624W.....	55		
1725120.....	31	1739415.....	75	3009938.....	65	BP825524.....	49		
1725125.....	31	1739420.....	75	3019101.....	93	BP826224.....	49		
1725130.....	31	1739425.....	75	3023460.....	94	BP826254.....	61		
1725133.....	31	1739430.....	75	3028786.....	94	BP826524.....	49		

The Buyers family of manufacturing companies

Tracom

B **Boomerang**
RUBBER, INC.

Romotech
Rotational Molding Technologies, Inc.

P **PROGRESSIVE**
POWDER COATING, INC.



See pages 86-87 for Wide Open Step Boxes

BuyersProducts.com

Buyers
PRODUCTS COMPANY

SnowDogg
by Buyers

SaltDogg
by Buyers

ScoopDogg
by Buyers

DumperDogg
by Buyers